

# PANELS

## kombi®

### DOOR PHONE SYSTEMS

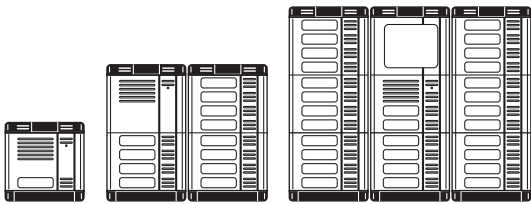

### VIDEO DOOR PHONE SYSTEMS

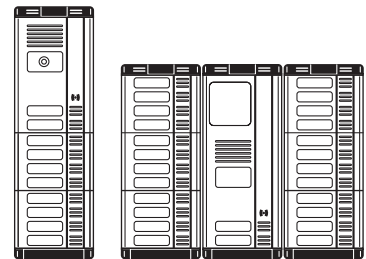
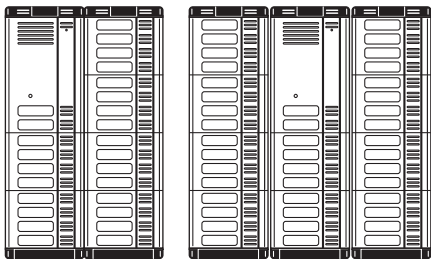
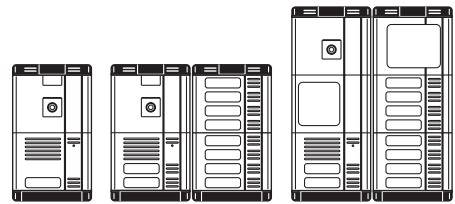

Download from:  
[www.urmetdomus.com](http://www.urmetdomus.com)  
Technical Manuals area  
MT101-013\_sez.2d.pdf

|  | <b>Section</b> | <b>Pag.</b> |
|--|----------------|-------------|
| <b>KOMBI PUSH BUTTON PANEL</b>   |                |             |
| ELECTRICAL AND MECHANICAL SPECIFICATIONS .....   | 2d             | 3           |
| CONFIGURATION .....  | 2d             | 3           |
| TECHNICAL FEATURES OF THE MODULES .....  | 2d             | 3           |
| MODULES ARRANGED FOR LOUDSPEAKING UNIT .....   | 2d             | 3           |
| Loudspeaking units .....   | 2d             | 4           |
| PUSH BUTTON MODULES .....  | 2d             | 4           |
| Name tag replacement .....   | 2d             | 5           |
| SPECIAL MODULES .....  | 2d             | 5           |
| Repertory modules .....  | 2d             | 5           |
| Blank modules Ref. 825/9 .....   | 2d             | 5           |
| KOMBI CAMERA UNIT .....  | 2d             | 5           |
| Coax camera unit .....   | 2d             | 6           |
| 5 Wire system camera unit .....  | 2d             | 7           |
| MODULE FRAMES COMPLETE WITH EMBEDDING BOX .....  | 2d             | 8           |
| Assembling embedding boxes .....   | 2d             | 8           |
| FLUSH-MOUNTED PANEL ACCESSORIES .....  | 2d             | 8           |
| Wall cover frame .....   | 2d             | 8           |
| Rain hood with wall cover frame .....  | 2d             | 9           |
| WALL-MOUNTED PANEL ACCESSORIES .....   | 2d             | 10          |
| Case and hood with frame and module holder .....   | 2d             | 10          |
| CONVERSATION PRIVACY DEVICE FOR "1+1" WIRE SYSTEMS Ref. 1035/74 .....                                  | 2d             | 11          |
| Insertion of the secrecy boards .....  | 2d             | 11          |
| CONVERSATION PRIVACY DEVICE FOR "4+n" WIRE SYSTEMS Ref. 5330/60 .....                                  | 2d             | 11          |
| KOMBI PANEL INSTALLATION - FLUSH-MOUNTED VERSION .....   | 2d             | 12          |
| DIMENSIONS .....   | 2d             | 14          |
| 4+n WIRE DOOR PHONE SYSTEMS - Examples of modular constructions with various capacities .....          | 2d             | 15          |
| 1+1 WIRE DOOR PHONE SYSTEMS - Examples of modular constructions with various capacities .....          | 2d             | 20          |
| B&W COAX VIDEO DOOR PHONE SYSTEMS - Examples of modular constructions with various capacities .....    | 2d             | 25          |
| COLOUR COAX VIDEO DOOR PHONE SYSTEMS - Examples of modular constructions with various capacities ..... | 2d             | 30          |
| B&W 5-WIRE VIDEO DOOR PHONE SYSTEMS - Examples of modular constructions with various capacities .....  | 2d             | 34          |
| COLOUR COAX VIDEO DOOR PHONE SYSTEMS - Examples of modular constructions with various capacities ..... | 2d             | 39          |

**KOMBI PUSH BUTTON PANEL**

The system is based on extruded aluminum modules that can be fitted on special frames complete with embedding box. The embedding boxes can be coupled horizontally by means of plastic spacers; through this system it is possible to compose push button panels for all types and configurations, with the smallest number of components, hence less need for stock management; thus, the advantage is reflected on the wholesaler and on the installer.

- Kombi panels can be used in the following system types:
- electronic or traditional call 4+n wire door phone systems;
  - 1+1 wire door phone systems;
  - B&W and colour coax video door phone systems;
  - B&W and colour 5 wire video door phone systems;
  - Duo free-hands door phone systems (see respective section);
  - Easivoice door phone systems.

**ELECTRICAL AND MECHANICAL SPECIFICATIONS**

Front width of one row with frame: **126 mm**  
 Front projection from wall: **12.5 mm**  
 Flush mounting box depth: **45 mm**

Front module finish: **anodised aluminium**  
 Urmet brand: **on module holder frame**

**Button body**  
 Isolation voltage between contacts: **50 V eff**  
 Max. button cut-off current: **2 A eff**

Name tag dimensions: **57 x 15.5 mm**  
 Tag and button light: **Tubular lamp bulb 15V 3W**  
 Tag protection: **plexiglas**

Max. wire cross-section area for button and light terminals: **1.5 mm<sup>2</sup>**  
 Degree of protection: **IP40 as per CEI 70.1 standard**  
 Corrosion: **as per DIN 5342/64 standard**  
 Test duration: **16 hours**  
 Test temperature range: **35°C**

**CONFIGURATION**

- The system may be used in the following versions:
- **wall embedding;**
  - **wall surface mounting.**
- The system is made of the following units:
- **modules;**
  - **module frames complete with embedding boxes;**
  - **accessories.**

**TECHNICAL FEATURES OF THE MODULES**

The different modules are assembled by fitting them in the columns of the module frames.  
 The modules are supplied in the following versions:

- Arranged for loudspeaking unit;
- With push buttons only;
- Special types.
- With camera unit

The modules have a natural anodised aluminium front panel.

The modules are fitted with 15V, 3W slim line bulbs. They should be powered with 12 V a.c. For up to a maximum of two bulbs, the house phone power supply used in the system is sufficient; for a greater number, an adequate power transformer is required.

A 9000/230 transformer can power up to 5 lamps. The name tags can be replaced and inserted from the outside without needing to remove the panel front.

The control buttons are made of metal.  
 The stairs light relay push button is suitable for controlling a low-voltage circuit (max. 24 V).

- The Kombi range includes single, double and triple modules which can be assembled according to needs. Module dimensions are:
- Single module: 125 x 90 mm.  
 Double module: 125 x 180 mm.  
 (1+1 wire door phone and 5 wire video door phone version)  
 Triple module: 125 x 270 mm.  
 (5 wire colour video door phone version)

**MODULES ARRANGED FOR LOUDSPEAKING UNIT**

There are two groups of modules with door unit set-up to be used according to the required system.

- The following module configurations are available:
- modules for 4+n wire door phone systems and coax wire video door phone systems:  
 Without call key **Ref. 825/210**  
 With 1 call key **Ref. 825/211**  
 With 2 call keys **Ref. 825/212**

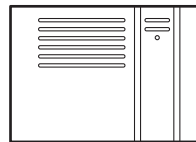

**Ref. 825/210**

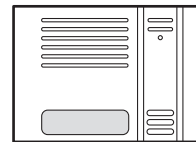

**Ref. 825/211**

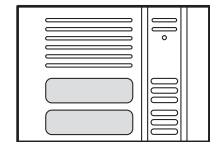

**Ref. 825/212**

- double modules for 1+1 wire systems.  
 Without call key **Ref. 825/15**  
 With 1 call key **Ref. 825/16**  
 With 2 call keys **Ref. 825/17**

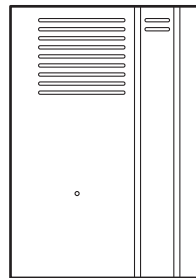

**Ref. 825/15**

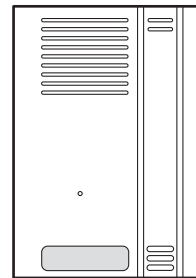

**Ref. 825/16**

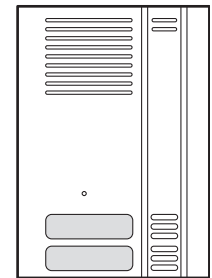

**Ref. 825/17**

All modules with door unit set-up are provided with a button for controlling the staircase light relay (low voltage).

**DESCRIPTION OF TERMINALS**

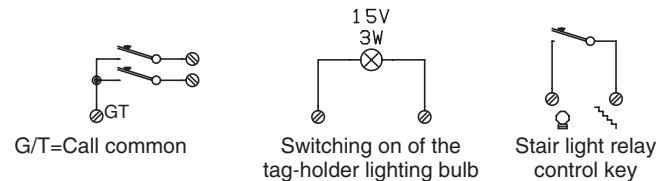

**NOTE:** *the call button and name tag light terminals are not present in 825/210 and 825/15 models*

**LOUDSPEAKING UNITS**

**LOUDSPEAKING UNIT Ref. 824/500**

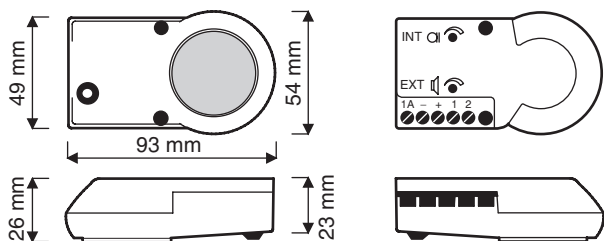

The amplified door unit Ref. 824/500 is particularly compact and normally fitted in Kombi modular panels Ref. 825 in 4+n wire door phone systems or coax video door phone systems.

The loudspeaking unit shall be inserted in the Kombi module arranged for loudspeaking unit, locating it in the proper place. Fixing of the loudspeaking unit to the push button panel box fixing supports is made by means of proper screws.

**DESCRIPTION OF TERMINALS**

- 1 A Electronic voice out (from speaker to door phone)
- Door unit power negative
- + Door unit power positive
- 1 Traditional voice out (from speaker to door phone)
- 2 Voice in (from microphone to door phone)

**Note:** use terminal "1A" in systems with Mod. 1131, 1132 and 1133 (Atlantico) door phones and terminal "1" for Mod. 1130 door phones.

**LOUDSPEAKING UNIT Ref. 1035/67**

Fit door unit Ref. 1035/67 in the panel for speak-and-listen service in "1+1" wire door phone systems and 5 wire video door phone systems.

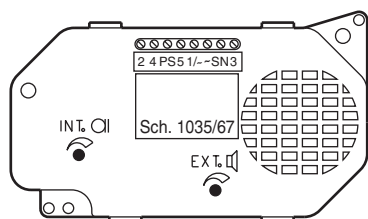

**DESCRIPTION OF TERMINALS**

- 2 Electrical lock control
- 4 Voice
- PS Electronic call two speaker
- 5 Electrical lock emergency relay control
- 1/~ Ground
- ~ Door unit 12Vac power
- SN Video power on for video door phone systems
- 3 Call buzzer (for Mod. 1130 door phones)

**LOUDSPEAKING UNIT MODULES WITH BUILT-IN ELECTRONICS**

The loudspeaking unit is already incorporated in these modules. They make it possible to obtain a higher voice level than the Ref. 824/500 loudspeaking units which means they can be used in particularly noisy and disturbed environments. The higher level of amplification is made possible by the fact that, as the loudspeaking unit circuit is an integral part of the Kombi module, it has been possible to improve acoustic coupling of the transducers. Due to problems of space, modules with integrated loudspeaking units do not have call buttons but are equipped with a single button for control of the stair light relay. In the case of a fault, the entire module must be replaced.

The module is available in the following version:

- Without call buttons

Ref. 825/220

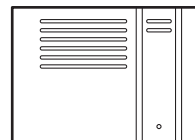

These modules are suitable for assembly in 4+n wire door phone systems and coax wire video door phone systems.

**DESCRIPTION OF TERMINALS**

- Door unit power negative
- 2 Voice in (from microphone to door phone)
- + Door unit power positive
- 1A Electronic voice out (from speaker to door phone)
- 1 Traditional voice out (from speaker to door phone)

**Note:** use terminal "1A" in systems with Mod. 1131, 1132 and 1133 (Atlantico) door phones and terminal "1" for Mod. 1130 door phones.

**AMPLIFICATION ADJUSTMENT**

All loudspeaking units use two separate integrated circuits for amplification towards the outside and towards the inside and an electret microphone as transmitter unit. Amplification in the two directions is adjustable using two trimmers accessible after open the frame.

As transmission levels are factory set to optimum values, it is advisable to modify these only if absolutely necessary (for example: elimination of "whining" or Larsen effect). In these cases, to avoid downgrading of acoustic equilibrium, it is advisable to use the trimmer that adjusts volume towards the outside.

To adjust external volume:

- use the trimmer identified with **EXT.** turning this in a clockwise direction to increase volume or in a anti-clockwise direction to reduce this.

To adjust internal volume:

- use the trimmer identified with **INT.** turning this in a clockwise direction to increase volume or in a anti-clockwise direction to reduce this.

**PUSH BUTTON MODULES**

The modules are supplies in the following versions:

- With 1 key

Ref. 825/201

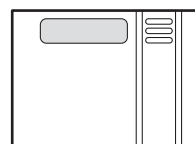

- With 2 keys

Ref. 825/202

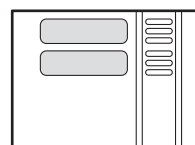

- With 3 keys

Ref. 825/203

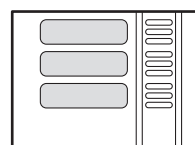

• With 4 keys

Ref. 825/204

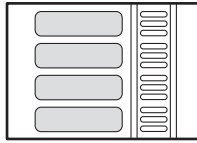

**DESCRIPTION OF TERMINALS**

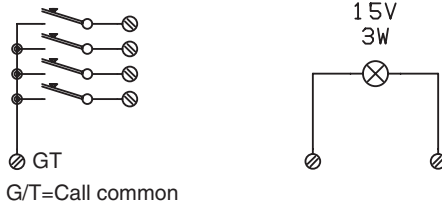

**NAME TAG REPLACEMENT**

The name tag can be inserted from the out-side; take off the outer plate by pressing the right-hand side and pushing outwards. This operation releases the plexiglass plate (57x 15.5 x 1.2 mm ) and the mylar card (0.1 mm thick). The plexiglass plate will be used for the definitive inscription of the corresponding name, while the mylar card can be used for an immediate temporary inscription.

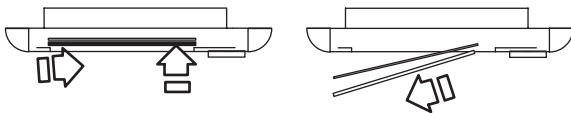

Do the contrary to reset the name tag and the outer plate.

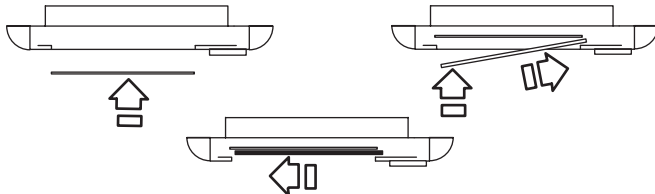

**SPECIAL MODULES**

The special modules are of two types:

- Repertory modules
- Blank module

**REPERTORY MODULES**

The repertory modules are usually used to indicate the house number or to write various information.

The repertory tag can be inserted from out-side only; take off the plate by pressing the left side and pushing inwards (Fig. A). See Fig. B to reset the tag.

• Repertory module

Ref. 825/5

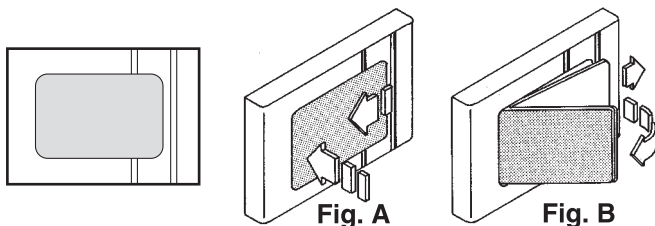

• Repertory module for 2 to 16 names

Ref. 825/550

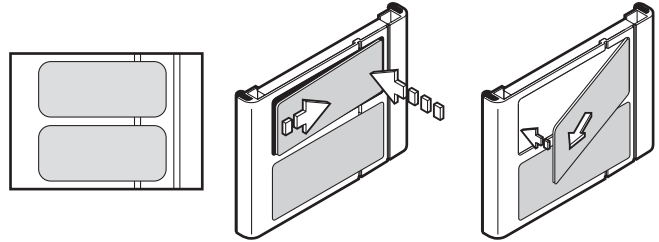

**BLANK MODULES Ref. 825/9**

This module is used to fill in spaces which are not used in modular applications as required.

The same module can be used for other application installing, e.g. electrical controls, burglar alarms and automatic gates.



**KOMBI CAMERA UNIT**

The following camera unit module versions are available:

**Coax system versions:**

- B&W 50 Hz without door unit **Ref. 825/70**
- B&W 60 Hz without door unit **Ref. 825/79**
- Colour without door unit **Ref. 1855/70**

**5-wire system versions:**

- With door unit, B&W, without buttons **Ref. 955/20**
- With door unit, B&W, with 1 button **Ref. 955/21**
- With door unit, B&W, with 2 buttons **Ref. 955/22**
- With door unit, colour, without buttons **Ref. 1855/20**
- With door unit, colour, with 1 button **Ref. 1855/21**
- With door unit, colour, with 2 buttons **Ref. 1855/22**

**TECHNICAL SPECIFICATIONS**

|  |                           |
|--|---------------------------|
| Power voltage:                         | 18 Vdc                    |
| Maximum uptake:                        | 300 mAdc                  |
| Image sensor:                          | 1/3" CCD                  |
| Lens:                                  | standard                  |
| Shutter:                               | standard                  |
| Focus:                                 | fixed                     |
| Minimum light for acceptable pictures: | 0.2 lux                   |
|  | <b>5 Lux recommended</b>  |
| Coax video output:                     | <b>1 Vpp composite</b>    |
| 5-wire video output:                   | <b>1 Vpp differential</b> |
| Operating temperature range:           | <b>from -5 to 50°C</b>    |

**COAX CAMERA UNIT**

**B&W CAMERA UNIT MODULE WITH ADJUSTABLE CCD CAMERA**

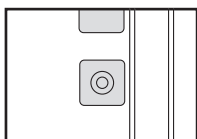

Easy to insert or remove from embedding box, it includes:

- TV camera with optics and shutter incorporated; focus adjustment is fixed. No other lenses can be used;
- possibility of adjusting camera lens vertically and horizontally;
- lighting system consisting of a set of infrared leds for lighting of the person;
- terminal connection board

Two TV camera units are available:

- without door unit 50 Hz **Ref. 825/70**
- without door unit 60Hz (not available in Italy) **Ref. 825/79**

**COLOUR DOOR CAMERA MODULE WITH ADJUSTABLE CCD CAMERA Ref. 1855/70**

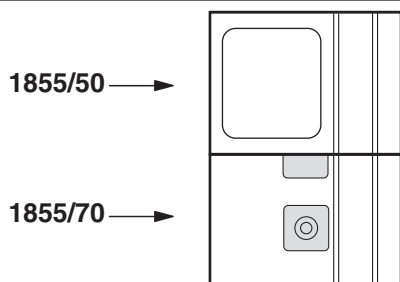

Features the same modular design as the black and white door camera unit. Additional space must be provided for the illuminator module, which must be installed as shown in figure.

**LIGHTING MODULE CONNECTION Ref. 1855/50**

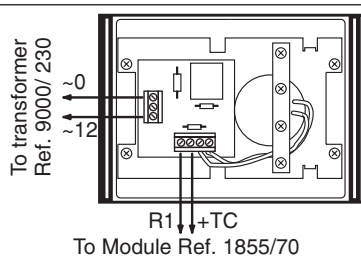

**Installation instructions**

Ref. 1855/50 module has to be used with Ref. 1855/70 colour CCD TV camera unit with adjustable pan and tilt. During installation, this function makes it possible to optimize the pick-up field.

**COAX CAMERA UNIT TERMINAL BOARD**

- ⊗ +TC Camera power positive
- ⊗ R1 Camera power negative
- ⊗ V5 Video signal earth
- ⊗ V3 Video signal

**IMAGING ANGLES**

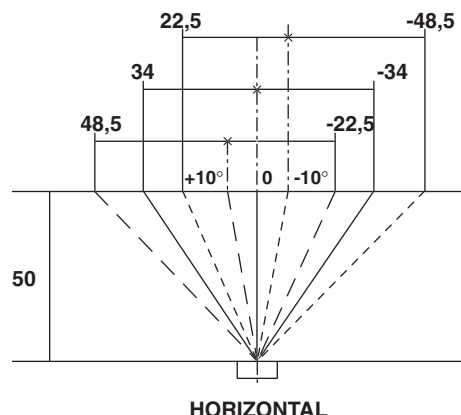

**HORIZONTAL**

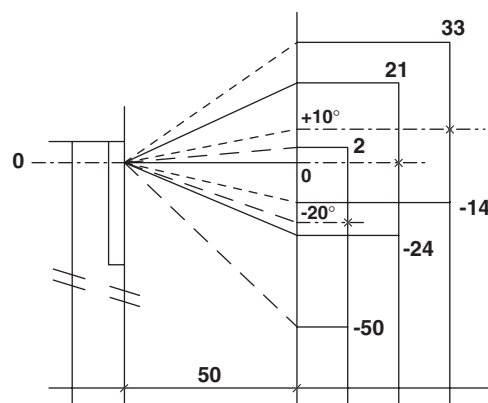

**VERTICAL**

Measurements in centimetres

**ADJUSTMENT OF TV CAMERA LENS ORIENTATION**

The Kombi video outdoor station make it possible to adjust the orientation of the lens of the TV camera located inside this using specific adjustment screws, indicated as A and B in the figure below, in order to offset any imperfections as regards installation.

The adjustment along the vertical axis in relation to the position set is 10° up and 20° down.

The adjustment along the horizontal axis in relation to the position set is 10° in both directions (left-right).

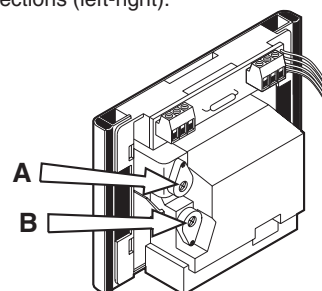

**Orientation along the vertical axis**

- If screw **A** is turned
- in a clockwise direction (to the right), the field framed is moved towards the bottom of the screen.
  - in a counter clockwise direction (to the left), the field framed is moved to the bottom of the screen.

**Orientation along the horizontal axis**

- Turning screw **B**:
- in a clockwise direction (to the right), the field framed is moved towards the left of the screen.
  - in a counter clockwise direction (to the left), the field framed is moved to the right of the screen.

**5 WIRE SYSTEM CAMERA UNIT**

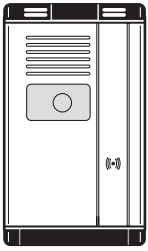

**Ref. 955/20**

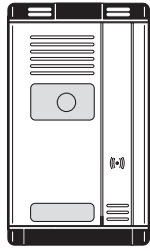

**Ref. 955/21**

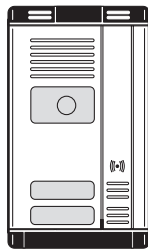

**Ref. 955/22**

Three models are available:

- TV camera module without keys
- TV camera module with 1 key
- TV camera module with 2 keys

**Ref. 955/20**

**Ref. 955/21**

**Ref. 955/22**

All the models are organized according to the two-modules Kombi structure and are furnished complete with:

- TV camera with C.C.D. solid-state sensor, with non-interchangeable optics and fixed focus adjustment;
- infrared LED subject illumination device;
- control electronics and loudspeaking unit;
- call secrecy (only for the call keys present);
- bulb to illuminate the name-tag holders (excluding the 955/20 model).

**COLOUR CCD AND TRANSMISSION CAMERA UNIT**

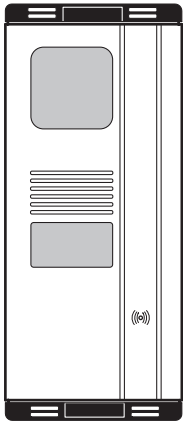

**Ref. 1855/20**

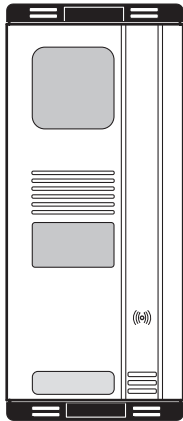

**Ref. 1855/21**

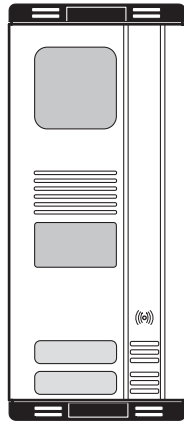

**Ref. 1855/22**

Three models are available:

- TV camera module without keys
- TV camera module with 1 key
- TV camera module with 2 keys

**Ref. 1855/20**

**Ref. 1855/21**

**Ref. 1855/22**

All the models are organized according to the three-module Kombi structure and are furnished complete with:

- CCD color TV camera with non-interchangeable optics and fixed focus;
- 12V 5W halogen light for illuminating the subject.
- control electronics and voice stage;
- call secrecy only for the call keys present;
- name tag with respective light (Ref. 1855/21 and Ref. 1855/22 only).

The entire system, excluding the halogen bulb, is powered by the Ref. 789/5B video power supply.

The Ref. 9000/230 with 12 Vac output safety transformer must be used to power the halogen bulb.

**DESCRIPTION OF TERMINALS**

|   |     |   |
|---|-----|---|
| ⊗ | PS  | Tone generator output                                       |
| ⊗ | ~   | Door unit power   |
| ⊗ | 1/~ | } Power ground  |
| ⊗ | 1/~ |   |
| ⊗ | SN  | Video power on control signal                               |
| ⊗ | 5   | (Electrical lock emergency relay control)                   |
| ⊗ | SE  | Electrical lock   |
| ⊗ | F   | Voice   |
| ⊗ | 4   | Conversation privacy device power                           |
| ⊗ | C2  | Call button (Ref. 955/22 and 1855/22 only)                  |
| ⊗ | C1  | Call button (Ref. 955/21, 955/22, 1855/21 and 1855/22 only) |
| ⊗ | R1  | Camera power negative                                       |
| ⊗ | +TC | Camera power positive                                       |
| ⊗ | B   | Differential video signal output (positive)                 |
| ⊗ | A   | Differential video signal output (negative)                 |
| ⊗ | LA  | } Lamp power (colour camera only)                           |
| ⊗ | LA  |   |

**IMAGING ANGLES**

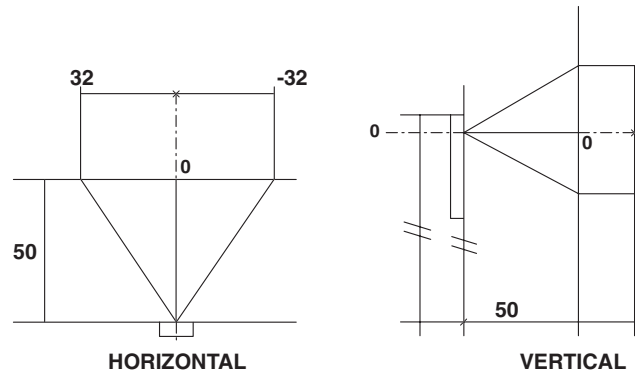

**Measurements in centimetres**

The frame angle of the camera is fixed. No adjustments are possible.

**CONTROLS AND ADJUSTMENTS**

Internal and external sound levels can be adjusted using the related volume trimmers on the rear cover.

The time in which the monitor lights up, following a call, may be adjusted between 45" and 180" using the specific trimmer on the video power supply.

The TV camera module has a built-in secrecy circuit, one for each button present.

To illuminate the name-tag holders, connect the bulb to the 12 V~ power supply (terminals ~, 1/~).

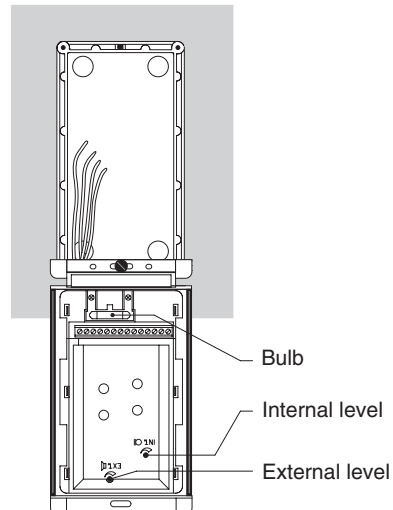



**MODULE FRAMES COMPLETE WITH EMBEDDING BOX**

The frame are supplied complete with head-stocks and columns to assemble the different modules.

The embedding box is 45 mm deep and after fitting the modules, they protrude from the wall by 12.5 mm.

The embedding boxes are joined to one another by means of special spacers to form push button panels with various configurations.

The frames are supplied in the following versions:

- For 1 module **Ref. 825/21**
- For 2 modules **Ref. 825/22**
- For 3 modules **Ref. 825/23**
- For 4 modules **Ref. 825/24**

**Note:** Two-, three- and four-module flush mounting back boxes and frames are supplied together with two type DST169 spacer grommets which can be used to join back boxes vertically where necessary.

**ASSEMBLING EMBEDDING BOXES**

The embedding boxes are assembled together using special spacers which also serve as wire conduit. If accessories are to be fitted, such as embedding frame, hood cover, surface mounted housing with hood cover, the maximum number of boxes that can be joined horizontally is three. If accessories are not used for embedded version, an unlimited number of embedding boxes can be used, to be joined together, both horizontally and vertically, by means of special wire conduit spacers. Said spacers are empty internally, to allow wire passage from a box to another one.

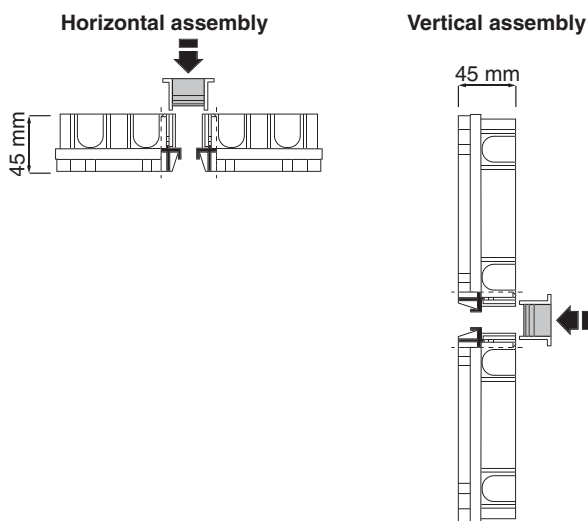

**FLUSH-MOUNTED PANEL ACCESSORIES**

**WALL COVER FRAME**

The frames are used to cover possible irregularities of the wall in the area surrounding the push button panel; they are inserted between the modules and the wall. Special rubber sealings prevent water from leaking in.

The following anodised aluminium frames are provided:

- For 1 module **Ref. 825/31**
- For 2 modules **Ref. 825/32**
- For 3 modules **Ref. 825/33**
- For 4 modules **Ref. 825/40A**

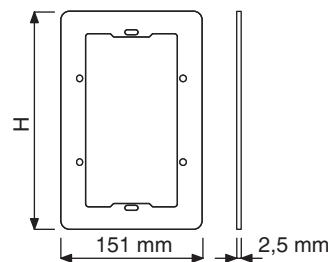

H is 148, 238, 328, and 418 mm for 1, 2, 3 and 4 module versions, respectively.

- For 4 modules (2 frames for 2 linked modules) **Ref. 825/34**
- For 6 modules (2 frames for 3 linked modules) **Ref. 825/36**
- For 8 modules (2 frames for 4 linked modules) **Ref. 825/40B**

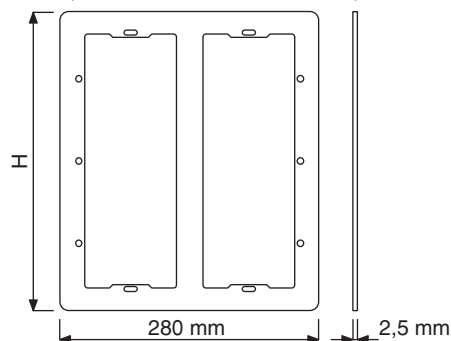

H is 238, 328, and 418 mm for 2, 3 and 4 module versions, respectively.

- For 9 modules (3 frames for 3 linked modules) **Ref. 825/39**
- For 12 modules (3 frames for 4 linked modules) **Ref. 825/412**

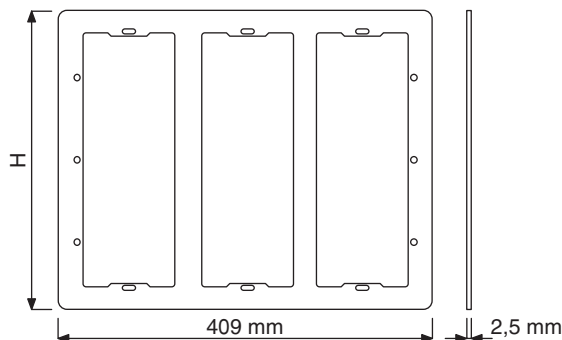

H is 328, and 418 mm for 3 and 4 module versions, respectively.



**INSTALLATION**

Once the embedding box has been walled, position the wall embedding frame and lock it by fastening the lower headstock of the module frame. The frame is then fixed completely by fastening the upper headstock of the module frame

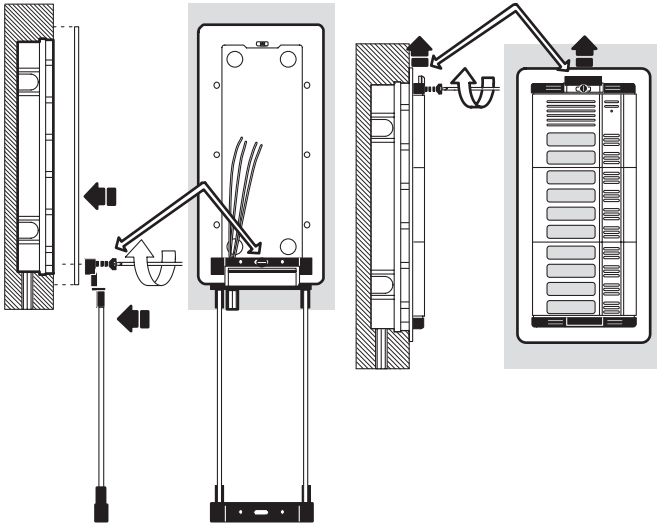

**RAIN HOOD WITH WALL COVER FRAME**

They are useful to make the panel installation weatherproof. The hood covers are inserted between the modules and the wall. They are supplied in the following versions:

- For 1 module
- For 2 modules
- For 3 modules
- For 4 modules

Ref. 825/41  
Ref. 825/42  
Ref. 825/43  
Ref. 825/441

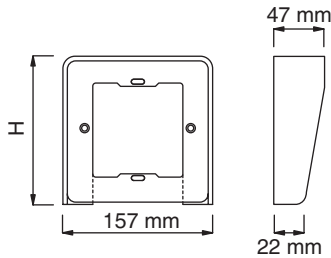

H is 151, 241, 331, and 421 mm for 1, 2, 3 and 4 module versions, respectively.

- For 4 modules (2 frames for 2 linked modules)
- For 6 modules (2 frames for 3 linked modules)
- For 8 modules (2 frames for 4 linked modules)

Ref. 825/44  
Ref. 825/46  
Ref. 825/442

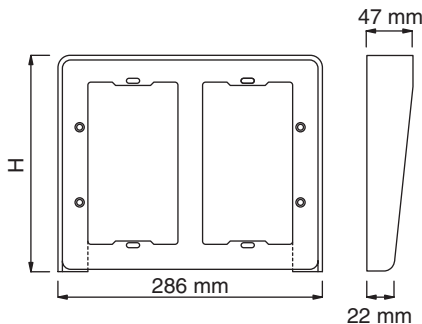

H is 241, 331, and 421 mm for 2, 3 and 4 module versions, respectively.

- For 9 modules (3 frames for 3 linked modules)
- For 12 modules (3 frames for 4 linked modules)

Ref. 825/49  
Ref. 825/443

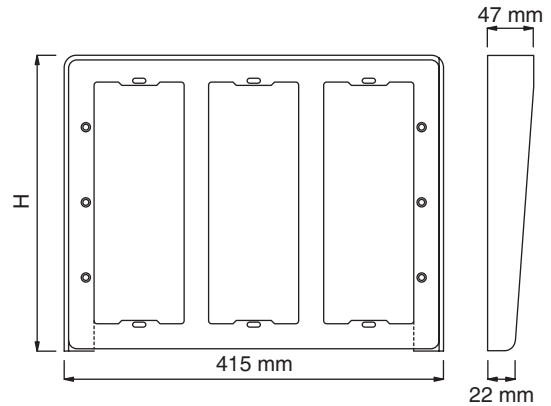

H is 331, and 421 mm for 3 and 4 module versions, respectively.

**INSTALLATION**

Once the embedding box has been walled, position the hood cover and lock it by fastening the lower headstock of the module frame. To avoid buckling and to compensate the difference in the lower support level of the hood cover, fasten in the embedding box lower side the proper two screws up to locate the head-stock about 2 mm out of the wall. The hood cover is then fixed completely by fastening the upper headstock of the module frame to the embedding box.

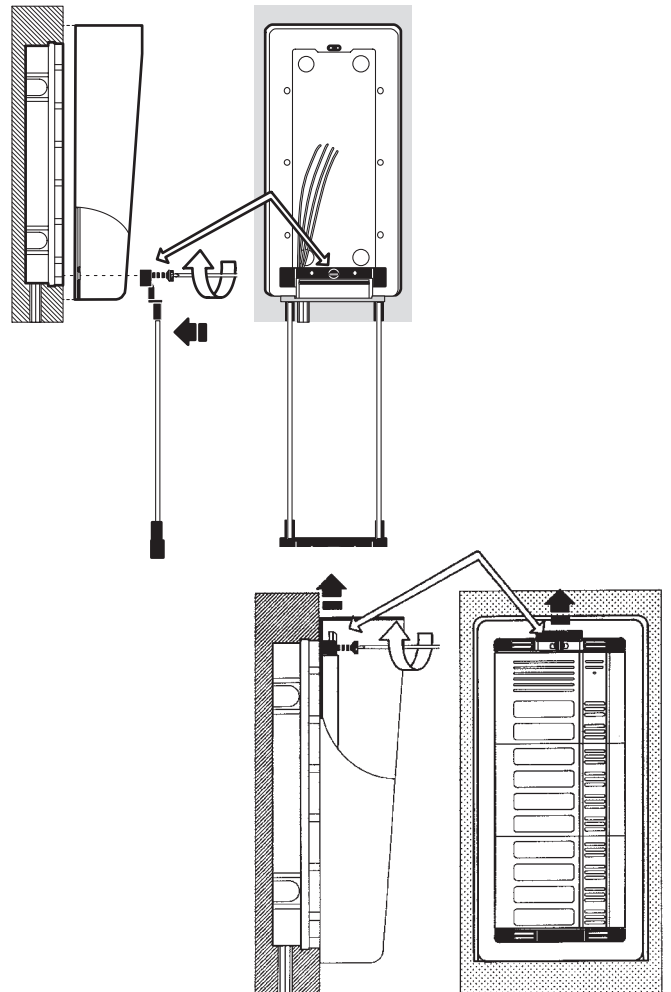

**WALL-MOUNTED PANEL ACCESSORIES**

**CASE AND HOOD WITH FRAME AND MODULE HOLDER**

Cases and hoods protect the panel from the weather and may be used for installation on walls without flush-mounted parts. The following versions are provided (with frame and module holder):

- For 1 module
- For 2 modules
- For 3 modules
- For 4 modules

**Ref. 825/51**  
**Ref. 825/52**  
**Ref. 825/53**  
**Ref. 825/541**

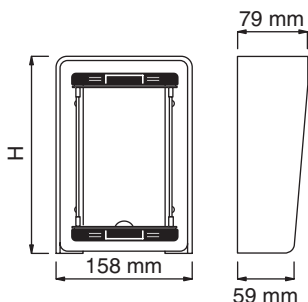

H is 151, 241, 331, and 421 mm for 1, 2, 3 and 4 module versions, respectively.

- For 4 modules (2 frames for 2 linked modules)
- For 6 modules (2 frames for 3 linked modules)
- For 8 modules (2 frames for 4 linked modules)

**Ref. 825/54**  
**Ref. 825/56**  
**Ref. 825/542**

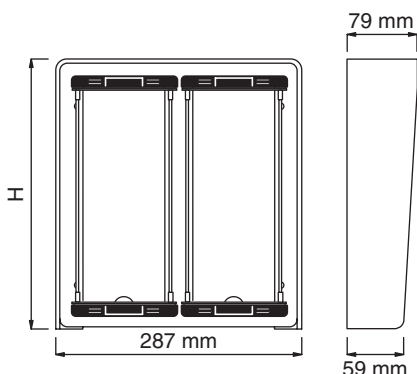

H is 241, 331, and 421 mm for 2, 3 and 4 module versions, respectively.

- For 9 modules (3 frames for 3 linked modules)
- For 12 modules (3 frames for 4 linked modules)

**Ref. 825/59**  
**Ref. 825/543**

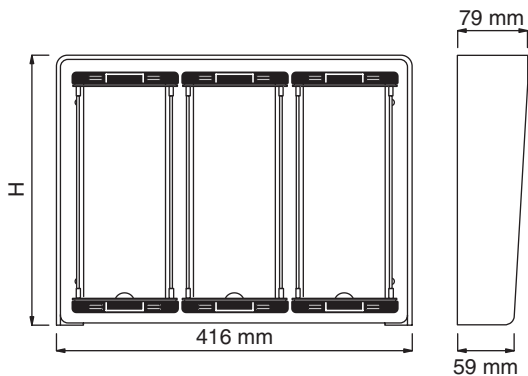

H is 331, and 421 mm for 3 and 4 module versions, respectively.

**INSTALLATION**

The housing is provided complete with embedding frame and module frame.

Fix the housing to the wall using three screws and corresponding plugs.

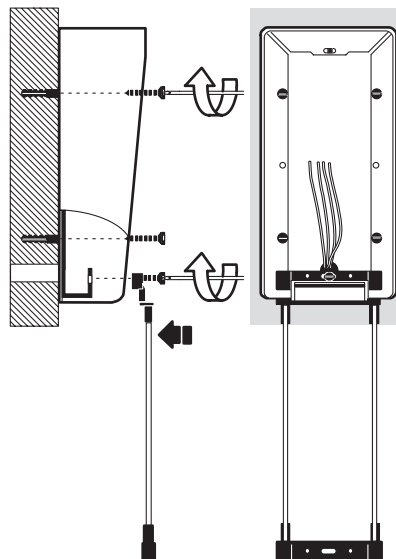

Open the hole in the lower area of the housing for passing the cables through. Fasten the lower headstock of the module frame, pinching the frame between the housing and headstock.

Take off the upper headstock and insert the needed modules in the frame.

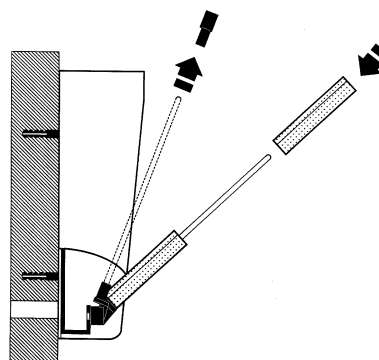

In the versions with 3 and 4 unit module frames, during assembly insert stiffener A between one module and the next; the stiffener is provided with the embedding boxes (2 for the 3-module version, 3 for the 4 module version).

Compact the different modules and refit the upper headstock. Fix the loudspeaking unit and make the necessary connections.

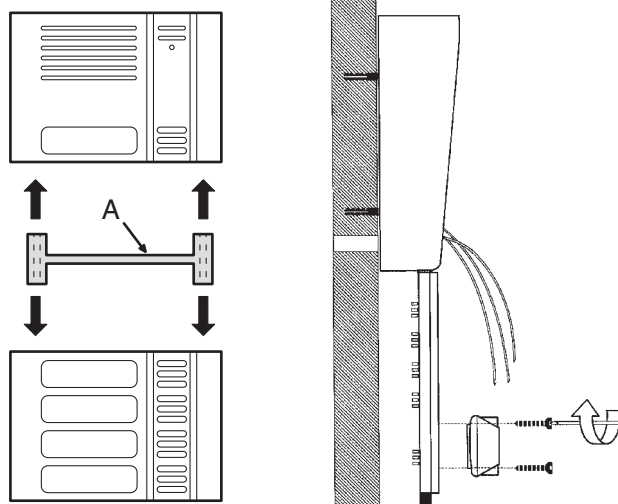

Close the plate and fix the upper headstock to the cover; the fastening screw is freed by lifting the special slider.

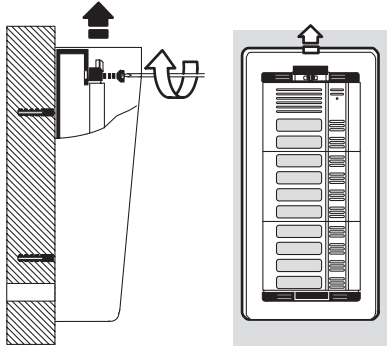

The broken board must be arranged as shown in the following drawing in the case of modules with door unit and 1 or 2 buttons.

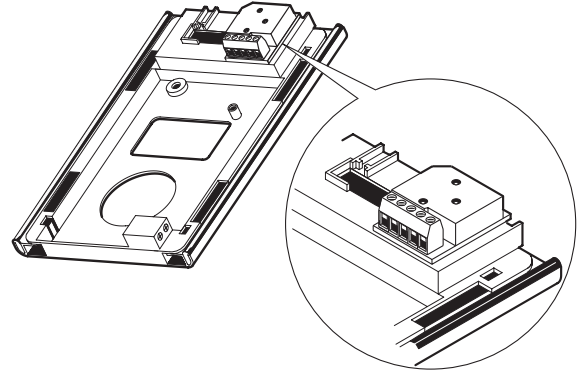

**Important:** connect the call wire to terminal C2 (not terminal C1) insingle button modules.

**CONVERSATION PRIVACY DEVICE FOR "1+1" WIRE SYSTEMS Ref. 1035/74**

Conversation privacy circuit boards Ref. 1035/74 must be inserted in the various modules with Kombi buttons in 1+1 wire door phone systems and 5 wire video door phone systems. Each board is sufficient for four buttons.

The number of secrecy boards to be used depends on system capacity.

When calculating the number of boards, take into account that the modules with TV camera Ref. 955/21, 955/22, 1855/21 and 1855/22 are already preset with 1 or 2 buttons and related secrecy boards.

The voice circuit of the called door phone or video door phone remains activated until the following call is made from the panel to another device. The door opening function is connected to conversation privacy; this means that a user must be called to be able to open the electrical lock.

**CONVERSATION PRIVACY DEVICE FOR "4+n" WIRE SYSTEMS Ref. 5330/60**

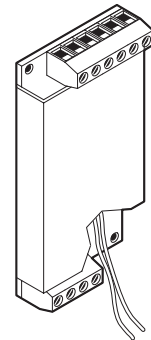

**INSERTION OF THE SECRECY BOARDS**

For insertion proceed as follows:

1. Remove screws **A** from the terminals of the Kombi module.
2. Rest the secrecy circuit so that the spacers of the container match the screw housings.
3. Fasten the secrecy circuit using the screws inserted inside the spacers.
4. Make the connections as indicated in the diagram. Wire 1 of the house phones must be connected directly to terminal 1/~ of the Loudspeaking unit.

Each call secrecy board is complete with 4 buttons. It can be used also for 2 buttons: in this case break the printed circuit as shown in Fig. 2 and use only **Section 2** (the one with 5 terminals).

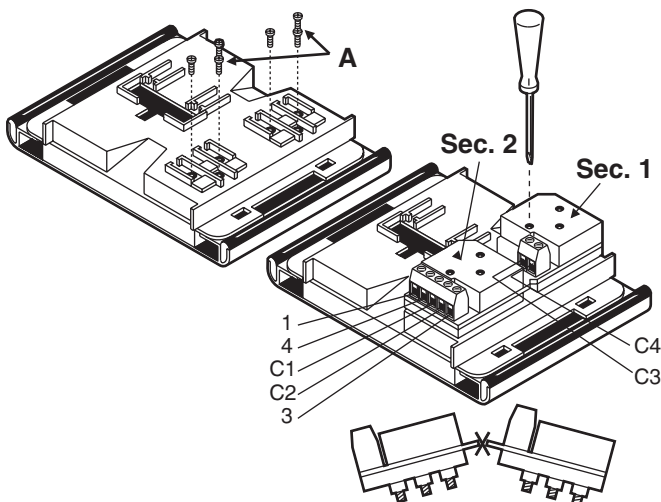

This device is used for conversation privacy function in 4+n door phone systems and coax video door phone systems, only. Fit device Ref. 1131/5 in each 1131 or 1132 door phone for the function; fit the video door phones on the specific conversation privacy bracket (Ref. 1202/95 for Winflat+ or Ref. 1704/95 for Sentry+).

The device shuts down privacy from previous calls and consequently ensures total privacy also if a door phone is forgotten off hook. All devices are normally deactivated (no conversation is heard when the handset is picked up): only the device called by the panel may start a conversation with the caller; no other device can take or intercept the call.

The device must be fastened to the flush-mounting box or case with hood with two screws.

Considering its size, the device must be fitted in button modules or special modules.

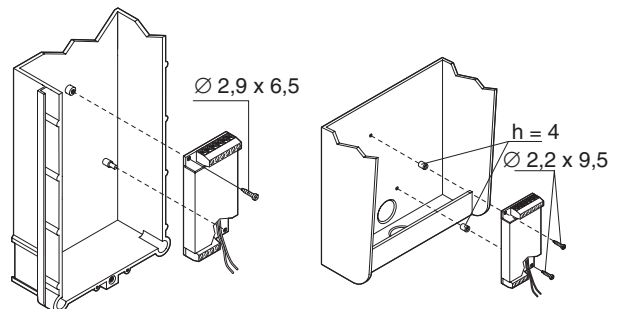

**KOMBI PANEL INSTALLATION - FLUSH-MOUNTED VERSION**

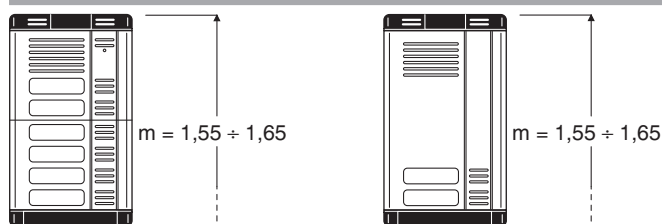

**4+n wire module with door unit**

**1+1 wire module with door unit**

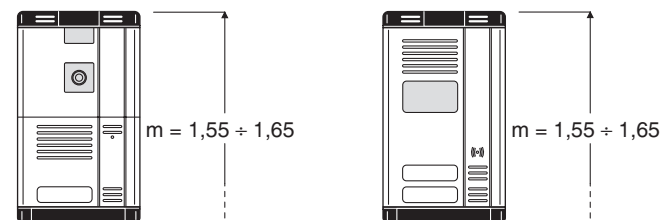

**Coax camera module**

**B&W 5 wire camera module**

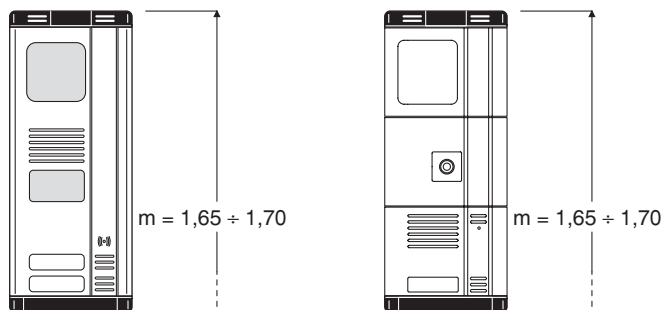

**Colour 5 wire camera module**

**Colour coax camera module**

In any case, consider the height shown in the figure for fastening the camera for correct installation of complex arrangement with several modules. The height refers to the door unit in door phone systems.

Before walling the embedding box, a hole (at the bottom or at the sides of the lower section) should be opened for passing the connection wires through.

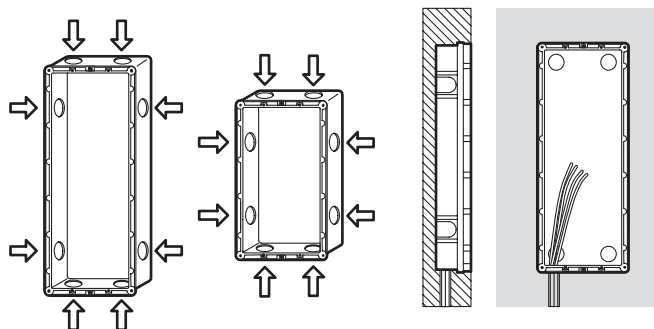

The embedding box must be walled on the level with the wall surface and must not protrude. If the box is embedded too deeply, loosen the two screws (on the lower side of the box) in the special holes until the screw head is flush with the wall; this is to prevent subsequent distortion of the lower head stock of the module frame during the screwing of the same on the embedding box.

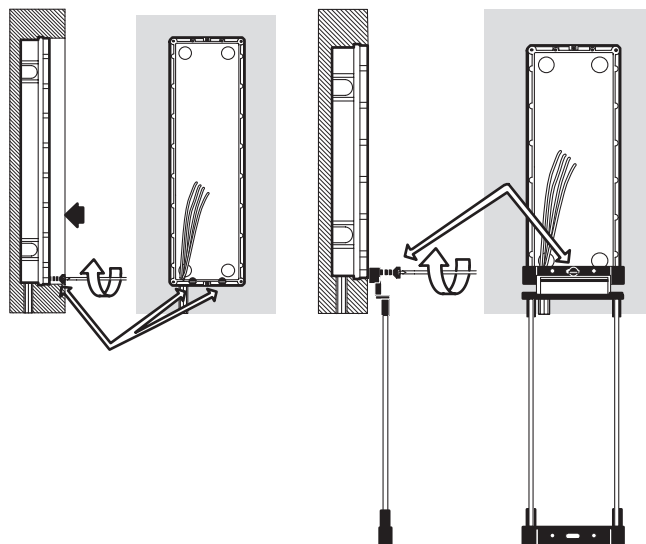

Once the embedding box has been fixed to the lower section of the module frame, take off the upper headstock and insert the required modules in the frame (the keys must all be positioned on the right-hand side).

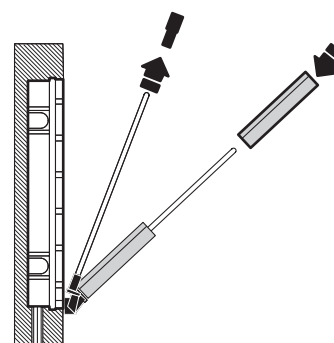

In the versions with 3 and 4 unit module frames, during assembly insert stiffener A between one module and the next; the stiffener is provided with the embedding boxes (2 for the 3-module version, 3 for the 4-module version).

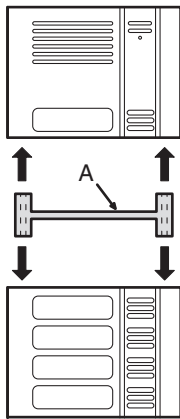

Refit the upper headstock; fix the loudspeaking unit and make the necessary connections.

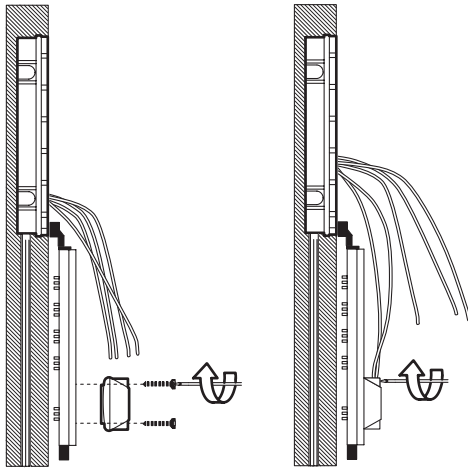

Close the front plate and fix the upper head-stock to the box (the fastening screw is freed by lifting the special slider).

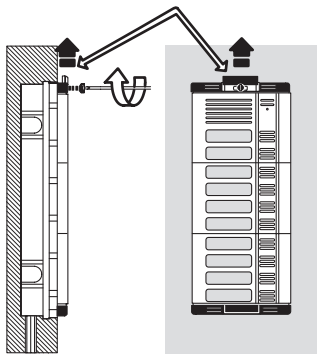

FLUSH-MOUNTED VERSION

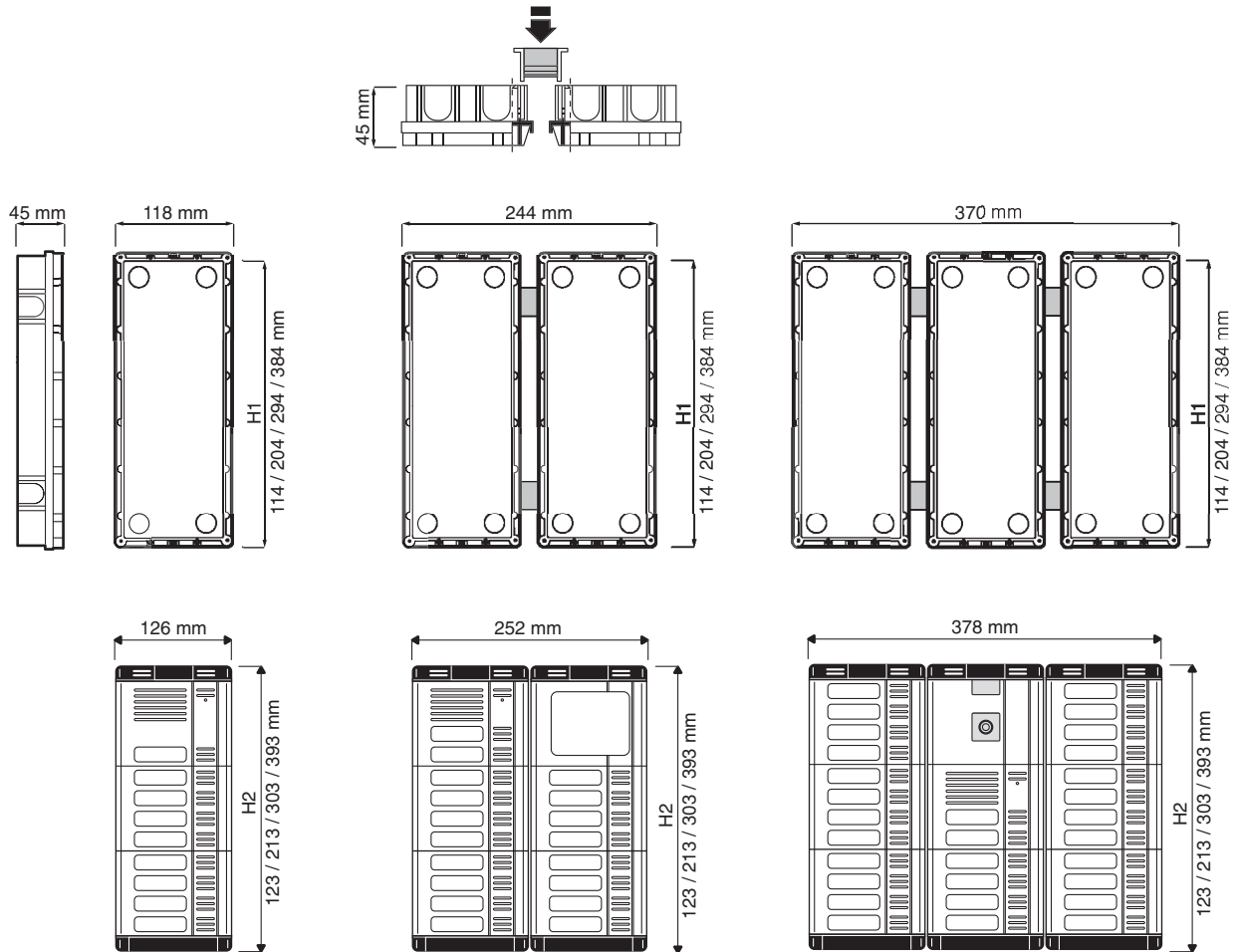

**Note:** H1= 114, 204, 294, 384 indicates flush mounting height and H2= 123, 213, 303, 393 indicates to total height relative to 1, 2, 3 and 4 module versions.

WALL-MOUNTED VERSION

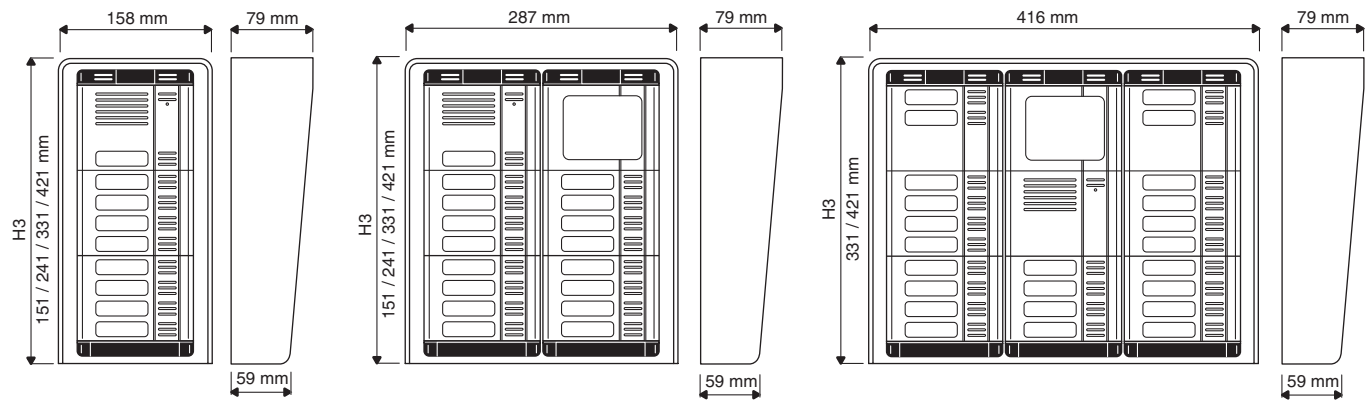

**Note:** H3 referred to the total height may differ according to the number of modules that the case may contain.

**EXAMPLES OF MODULAR CONSTRUCTIONS WITH VARIOUS CAPACITIES**

(°) alternatives  
(#) alternatives



**1**



**2**



**3**

|                            |  |                  |         |         |         |
|----------------------------|--|------------------|---------|---------|---------|
|                            | Loudspeaking units                       | 824/500          | 824/500 | 824/500 |         |
|                            | Modules arranged for loudspeaking unit   | 825/211          | 825/212 | 825/210 |         |
|                            | Push button modules                      | Repertory module | -       | -       | 825/203 |
| FLUSH MOUNTED (#)          | Module frames with embedding box         | 825/21           | 825/21  | 825/22  |         |
| FLUSH-MOUNTING ACCESSORIES | Wall cover frame (°)                     | 825/31           | 825/31  | 825/32  |         |
|                            | Rain hood with wall cover frame (°)      | 825/41           | 825/41  | 825/42  |         |
| WALL MOUNTED (#)           | Case with hood, frame and module holders | 825/51           | 825/51  | 825/52  |         |



**4**



**5**



**6**

|                            |  |                  |         |         |         |
|----------------------------|--|------------------|---------|---------|---------|
|                            | Loudspeaking units                       | 824/500          | 824/500 | 824/500 |         |
|                            | Modules arranged for loudspeaking unit   | 825/210          | 825/211 | 825/212 |         |
|                            | Push button modules                      | Repertory module | 825/204 | -       | 825/204 |
| FLUSH MOUNTED (#)          | Module frames with embedding box         | 825/22           | 825/22  | 825/22  |         |
| FLUSH-MOUNTING ACCESSORIES | Wall cover frame (°)                     | 825/32           | 825/32  | 825/32  |         |
|                            | Rain hood with wall cover frame (°)      | 825/42           | 825/42  | 825/42  |         |
| WALL MOUNTED (#)           | Case with hood, frame and module holders | 825/52           | 825/52  | 825/52  |         |



**7**



**8**



**9**

|                            |  |                  |                           |         |             |   |             |
|----------------------------|--|------------------|---------------------------|---------|-------------|---|-------------|
|                            | Loudspeaking units                       | 824/500          | 824/500                   | 824/500 |             |   |             |
|                            | Modules arranged for loudspeaking unit   | 825/210          | 825/210                   | 825/211 |             |   |             |
|                            | Push button modules                      | Repertory module | 1 x 825/203 - 1 x 825/204 | -       | 2 x 825/204 | - | 2 x 825/204 |
| FLUSH MOUNTED (#)          | Module frames with embedding box         | 825/23           | 825/23                    | 825/23  |             |   |             |
| FLUSH-MOUNTING ACCESSORIES | Wall cover frame (°)                     | 825/33           | 825/33                    | 825/33  |             |   |             |
|                            | Rain hood with wall cover frame (°)      | 825/43           | 825/43                    | 825/43  |             |   |             |
| WALL MOUNTED (#)           | Case with hood, frame and module holders | 825/53           | 825/53                    | 825/53  |             |   |             |

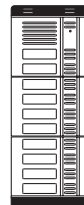

**10**

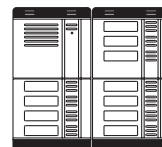

**11**

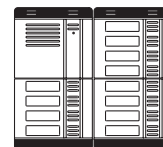

**12**

|                            |  |                  |             |            |                           |   |             |
|----------------------------|--|------------------|-------------|------------|---------------------------|---|-------------|
|                            | Loudspeaking units                       | 824/500          | 824/500     | 824/500    |                           |   |             |
|                            | Modules arranged for loudspeaking unit   | 825/212          | 825/210     | 825/210    |                           |   |             |
|                            | Push button modules                      | Repertory module | 2 x 825/204 | -          | 1 x 825/203 - 2 x 825/204 | - | 3 x 825/204 |
| FLUSH MOUNTED (#)          | Module frames with embedding box         | 825/23           | 2 x 825/22  | 2 x 825/22 |                           |   |             |
| FLUSH-MOUNTING ACCESSORIES | Wall cover frame (°)                     | 825/33           | 825/34      | 825/34     |                           |   |             |
|                            | Rain hood with wall cover frame (°)      | 825/43           | 825/44      | 825/44     |                           |   |             |
| WALL MOUNTED (#)           | Case with hood, frame and module holders | 825/53           | 825/54      | 825/54     |                           |   |             |



(°) alternatives  
(#) alternatives

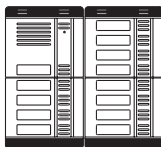

**13**

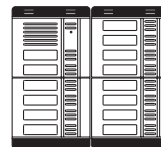

**14**

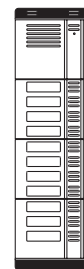

**11**

|                            |  |                  |             |   |             |   |                           |   |
|----------------------------|--|------------------|-------------|---|-------------|---|---------------------------|---|
| Loudspeaking units         |  |                  | 824/500     |   | 824/500     |   | 824/500                   |   |
|                            | Modules arranged for loudspeaking unit   |                  | 825/211     |   | 825/212     |   | 825/210                   |   |
|                            | Push button modules                      | Repertory module | 3 x 825/204 | - | 3 x 825/204 | - | 1 x 825/203 - 2 x 825/204 | - |
| FLUSH MOUNTED (#)          | Module frames with embedding box         |                  | 2 x 825/22  |   | 2 x 825/22  |   | 825/24                    |   |
| FLUSH-MOUNTING ACCESSORIES | Wall cover frame (°)                     |                  | 825/34      |   | 825/34      |   | 825/404                   |   |
|                            | Rain hood with wall cover frame (°)      |                  | 825/44      |   | 825/44      |   | 825/441                   |   |
| WALL MOUNTED (#)           | Case with hood, frame and module holders |                  | 825/54      |   | 825/54      |   | 825/541                   |   |

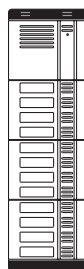

**12**



**13**

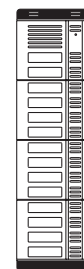

**14**

|                            |  |                  |             |   |             |   |             |   |
|----------------------------|--|------------------|-------------|---|-------------|---|-------------|---|
| Loudspeaking units         |  |                  | 824/500     |   | 824/500     |   | 824/500     |   |
|                            | Modules arranged for loudspeaking unit   |                  | 825/210     |   | 825/211     |   | 825/212     |   |
|                            | Push button modules                      | Repertory module | 3 x 825/204 | - | 3 x 825/204 | - | 3 x 825/204 | - |
| FLUSH MOUNTED (#)          | Module frames with embedding box         |                  | 825/24      |   | 825/24      |   | 825/24      |   |
| FLUSH-MOUNTING ACCESSORIES | Wall cover frame (°)                     |                  | 825/404     |   | 825/404     |   | 825/404     |   |
|                            | Rain hood with wall cover frame (°)      |                  | 825/441     |   | 825/441     |   | 825/441     |   |
| WALL MOUNTED (#)           | Case with hood, frame and module holders |                  | 825/541     |   | 825/541     |   | 825/541     |   |

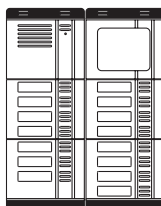

**15**

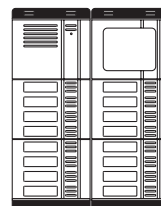

**16**

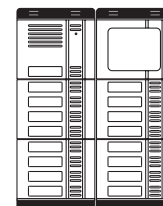

**17**

|                            |  |                  |                           |       |             |       |             |       |
|----------------------------|--|------------------|---------------------------|-------|-------------|-------|-------------|-------|
| Loudspeaking units         |  |                  | 824/500                   |       | 824/500     |       | 824/500     |       |
|                            | Modules arranged for loudspeaking unit   |                  | 825/210                   |       | 825/210     |       | 825/211     |       |
|                            | Push button modules                      | Repertory module | 1 x 825/203 - 3 x 825/204 | 825/5 | 4 x 825/204 | 825/5 | 4 x 825/204 | 825/5 |
| FLUSH MOUNTED (#)          | Module frames with embedding box         |                  | 2 x 825/23                |       | 2 x 825/23  |       | 2 x 825/23  |       |
| FLUSH-MOUNTING ACCESSORIES | Wall cover frame (°)                     |                  | 825/36                    |       | 825/36      |       | 825/36      |       |
|                            | Rain hood with wall cover frame (°)      |                  | 825/46                    |       | 825/46      |       | 825/46      |       |
| WALL MOUNTED (#)           | Case with hood, frame and module holders |                  | 825/56                    |       | 825/56      |       | 825/56      |       |

**EXAMPLES OF MODULAR CONSTRUCTIONS WITH VARIOUS CAPACITIES**

(°) alternatives  
(#) alternatives

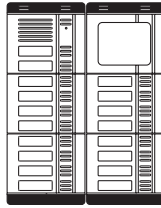

**18**

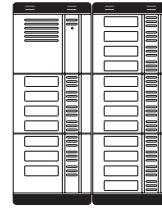

**19**

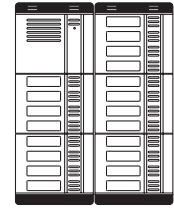

**20**

|                            |  |             |       |                           |   |             |   |
|----------------------------|--|-------------|-------|---------------------------|---|-------------|---|
|                            | Loudspeaking units                       | 824/500     |       | 824/500                   |   | 824/500     |   |
|                            | Modules arranged for loudspeaking unit   | 825/212     |       | 825/210                   |   | 825/210     |   |
|                            | Push button modules                      | 4 x 825/204 | 825/5 | 1 x 825/203 - 4 x 825/204 | - | 5 x 825/204 | - |
| FLUSH MOUNTED (#)          | Module frames with embedding box         | 2 x 825/23  |       | 2 x 825/23                |   | 2 x 825/23  |   |
| FLUSH-MOUNTING ACCESSORIES | Wall cover frame (°)                     | 825/36      |       | 825/36                    |   | 825/36      |   |
|                            | Rain hood with wall cover frame (°)      | 825/46      |       | 825/46                    |   | 825/46      |   |
| WALL MOUNTED (#)           | Case with hood, frame and module holders | 825/56      |       | 825/56                    |   | 825/56      |   |

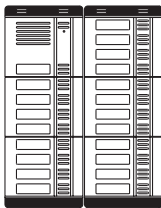

**21**

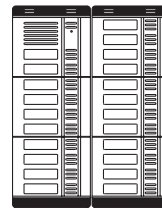

**22**

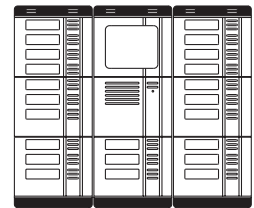

**23**

|                            |  |             |   |             |   |                           |       |
|----------------------------|--|-------------|---|-------------|---|---------------------------|-------|
|                            | Loudspeaking units                       | 824/500     |   | 824/500     |   | 824/500                   |       |
|                            | Modules arranged for loudspeaking unit   | 825/211     |   | 825/212     |   | 825/210                   |       |
|                            | Push button modules                      | 5 x 825/204 | - | 5 x 825/204 | - | 5 x 825/203 - 2 x 825/204 | 825/5 |
| FLUSH MOUNTED (#)          | Module frames with embedding box         | 2 x 825/23  |   | 2 x 825/23  |   | 3 x 825/23                |       |
| FLUSH-MOUNTING ACCESSORIES | Wall cover frame (°)                     | 825/36      |   | 825/36      |   | 825/39                    |       |
|                            | Rain hood with wall cover frame (°)      | 825/46      |   | 825/46      |   | 825/49                    |       |
| WALL MOUNTED (#)           | Case with hood, frame and module holders | 825/56      |   | 825/56      |   | 825/59                    |       |

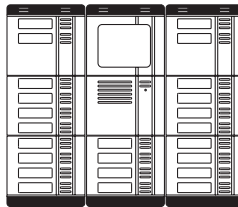

**24**

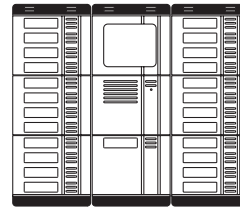

**25**

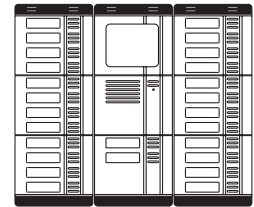

**26**

|                            |  |                           |       |                           |       |                           |       |
|----------------------------|--|---------------------------|-------|---------------------------|-------|---------------------------|-------|
|                            | Loudspeaking units                       | 824/500                   |       | 824/500                   |       | 824/500                   |       |
|                            | Modules arranged for loudspeaking unit   | 825/210                   |       | 825/210                   |       | 825/210                   |       |
|                            | Push button modules                      | 2 x 825/202 - 5 x 825/204 | 825/5 | 1 x 825/201 - 6 x 825/204 | 825/5 | 1 x 825/202 - 6 x 825/204 | 825/5 |
| FLUSH MOUNTED (#)          | Module frames with embedding box         | 3 x 825/23                |       | 3 x 825/23                |       | 3 x 825/23                |       |
| FLUSH-MOUNTING ACCESSORIES | Wall cover frame (°)                     | 825/39                    |       | 825/39                    |       | 825/39                    |       |
|                            | Rain hood with wall cover frame (°)      | 825/49                    |       | 825/49                    |       | 825/49                    |       |
| WALL MOUNTED (#)           | Case with hood, frame and module holders | 825/59                    |       | 825/59                    |       | 825/59                    |       |

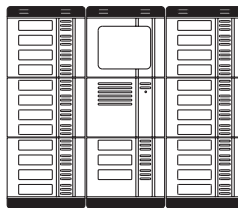

**27**

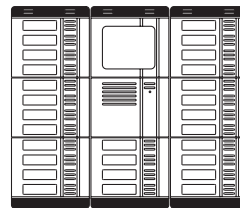

**28**

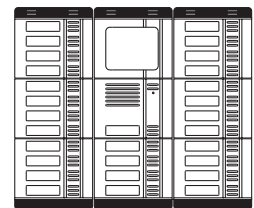

**29**

|                            |  |                           |       |             |       |             |       |
|----------------------------|--|---------------------------|-------|-------------|-------|-------------|-------|
|                            | Loudspeaking units                       | 824/500                   |       | 824/500     |       | 824/500     |       |
|                            | Modules arranged for loudspeaking unit   | 825/210                   |       | 825/210     |       | 825/211     |       |
|                            | Push button modules                      | 1 x 825/203 - 6 x 825/204 | 825/5 | 7 x 825/204 | 825/5 | 7 x 825/204 | 825/5 |
| FLUSH MOUNTED (#)          | Module frames with embedding box         | 3 x 825/23                |       | 3 x 825/23  |       | 3 x 825/23  |       |
| FLUSH-MOUNTING ACCESSORIES | Wall cover frame (°)                     | 825/39                    |       | 825/39      |       | 825/39      |       |
|                            | Rain hood with wall cover frame (°)      | 825/49                    |       | 825/49      |       | 825/49      |       |
| WALL MOUNTED (#)           | Case with hood, frame and module holders | 825/59                    |       | 825/59      |       | 825/59      |       |

### EXAMPLES OF MODULAR CONSTRUCTIONS WITH VARIOUS CAPACITIES

(°) alternatives  
(#) alternatives

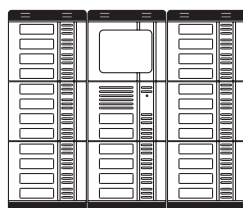

**30**



**31**



**32**

|                            |  |                  |             |       |                           |   |             |   |
|----------------------------|--|------------------|-------------|-------|---------------------------|---|-------------|---|
| Loudspeaking units         | 824/500                                  |                  | 824/500     |       | 824/500                   |   |             |   |
|                            | Modules arranged for loudspeaking unit   |                  | 825/212     |       | 825/210                   |   |             |   |
|                            | Push button modules                      | Repertory module | 7 x 825/204 | 825/5 | 1 x 825/203 - 7 x 825/204 | - | 8 x 825/204 | - |
| FLUSH MOUNTED (#)          | Module frames with embedding box         |                  | 3 x 825/23  |       | 3 x 825/23                |   | 3 x 825/23  |   |
| FLUSH-MOUNTING ACCESSORIES | Wall cover frame (°)                     |                  | 825/39      |       | 825/39                    |   | 825/39      |   |
|                            | Rain hood with wall cover frame (°)      |                  | 825/49      |       | 825/49                    |   | 825/49      |   |
| WALL MOUNTED (#)           | Case with hood, frame and module holders |                  | 825/59      |       | 825/59                    |   | 825/59      |   |

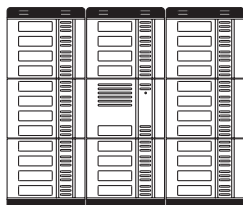

**33**

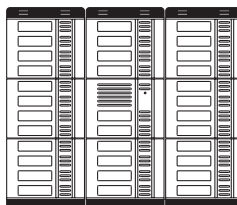

**34**

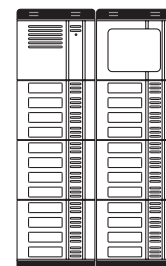

**24**

|                            |  |                  |             |   |             |   |             |       |
|----------------------------|--|------------------|-------------|---|-------------|---|-------------|-------|
| Loudspeaking units         | 824/500                                  |                  | 824/500     |   | 824/500     |   |             |       |
|                            | Modules arranged for loudspeaking unit   |                  | 825/211     |   | 825/212     |   | 825/210     |       |
|                            | Push button modules                      | Repertory module | 8 x 825/204 | - | 8 x 825/204 | - | 6 x 825/204 | 825/5 |
| FLUSH MOUNTED (#)          | Module frames with embedding box         |                  | 3 x 825/23  |   | 3 x 825/23  |   | 2 x 825/24  |       |
| FLUSH-MOUNTING ACCESSORIES | Wall cover frame (°)                     |                  | 825/39      |   | 825/39      |   | 825/408     |       |
|                            | Rain hood with wall cover frame (°)      |                  | 825/49      |   | 825/49      |   | 825/442     |       |
| WALL MOUNTED (#)           | Case with hood, frame and module holders |                  | 825/59      |   | 825/59      |   | 825/542     |       |

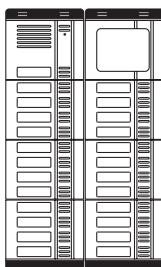

**25**

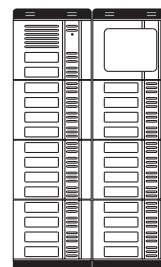

**26**

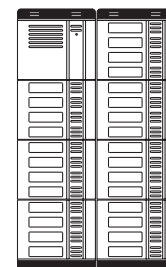

**28**

|                            |  |                  |             |       |             |       |             |   |
|----------------------------|--|------------------|-------------|-------|-------------|-------|-------------|---|
| Loudspeaking units         | 824/500                                  |                  | 824/500     |       | 824/500     |       |             |   |
|                            | Modules arranged for loudspeaking unit   |                  | 825/211     |       | 825/212     |       | 825/210     |   |
|                            | Push button modules                      | Repertory module | 6 x 825/204 | 825/5 | 6 x 825/204 | 825/5 | 7 x 825/204 | - |
| FLUSH MOUNTED (#)          | Module frames with embedding box         |                  | 2 x 825/24  |       | 2 x 825/24  |       | 2 x 825/24  |   |
| FLUSH-MOUNTING ACCESSORIES | Wall cover frame (°)                     |                  | 825/408     |       | 825/408     |       | 825/408     |   |
|                            | Rain hood with wall cover frame (°)      |                  | 825/442     |       | 825/442     |       | 825/442     |   |
| WALL MOUNTED (#)           | Case with hood, frame and module holders |                  | 825/542     |       | 825/542     |       | 825/542     |   |

(°) alternatives  
(#) alternatives

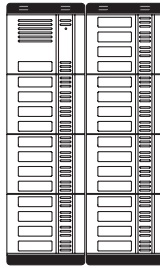

29

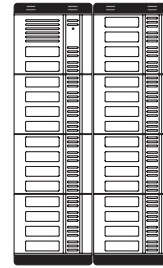

30

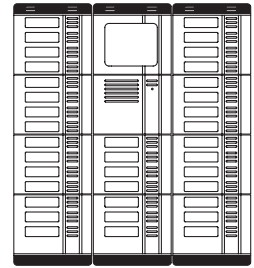

37

|                            |  |                  |             |            |             |            |                                   |
|----------------------------|--|------------------|-------------|------------|-------------|------------|-----------------------------------|
|                            | Loudspeaking units                       | 824/500          |             | 824/500    |             | 824/500    |                                   |
|                            | Modules arranged for loudspeaking unit   | 825/211          |             | 825/212    |             | 825/210    |                                   |
|                            | Push button modules                      | Repertory module | 7 x 825/204 | -          | 7 x 825/204 | -          | 3 x 825/203 - 7 x 825/204   825/5 |
| FLUSH MOUNTED (#)          | Module frames with embedding box         | 2 x 825/24       |             | 2 x 825/24 |             | 3 x 825/24 |                                   |
| FLUSH-MOUNTING ACCESSORIES | Wall cover frame (°)                     | 825/408          |             | 825/408    |             | 825/412    |                                   |
|                            | Rain hood with wall cover frame (°)      | 825/442          |             | 825/442    |             | 825/443    |                                   |
| WALL MOUNTED (#)           | Case with hood, frame and module holders | 825/542          |             | 825/542    |             | 825/543    |                                   |

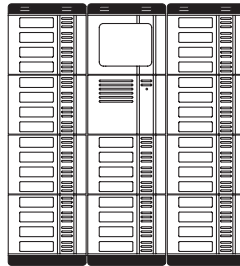

40

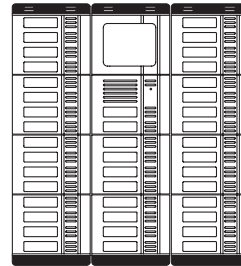

42

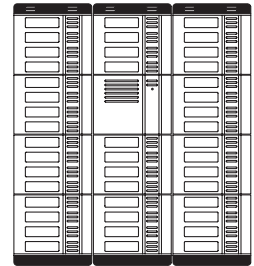

44

|                            |  |                  |              |            |              |            |                  |
|----------------------------|--|------------------|--------------|------------|--------------|------------|------------------|
|                            | Loudspeaking units                       | 824/500          |              | 824/500    |              | 824/500    |                  |
|                            | Modules arranged for loudspeaking unit   | 825/210          |              | 825/212    |              | 825/210    |                  |
|                            | Push button modules                      | Repertory module | 10 x 825/204 | 825/5      | 10 x 825/204 | 825/5      | 11 x 825/204   - |
| FLUSH MOUNTED (#)          | Module frames with embedding box         | 3 x 825/24       |              | 3 x 825/24 |              | 3 x 825/24 |                  |
| FLUSH-MOUNTING ACCESSORIES | Wall cover frame (°)                     | 825/412          |              | 825/412    |              | 825/412    |                  |
|                            | Rain hood with wall cover frame (°)      | 825/443          |              | 825/443    |              | 825/443    |                  |
| WALL MOUNTED (#)           | Case with hood, frame and module holders | 825/543          |              | 825/543    |              | 825/543    |                  |

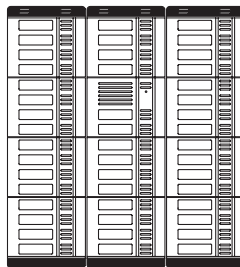

46

|                            |  |                  |              |
|----------------------------|--|------------------|--------------|
|                            | Loudspeaking units                       | 824/500          |              |
|                            | Modules arranged for loudspeaking unit   | 825/212          |              |
|                            | Push button modules                      | Repertory module | 11 x 825/204 |
| FLUSH MOUNTED (#)          | Module frames with embedding box         | 3 x 825/24       |              |
| FLUSH-MOUNTING ACCESSORIES | Wall cover frame (°)                     | 825/412          |              |
|                            | Rain hood with wall cover frame (°)      | 825/443          |              |
| WALL MOUNTED (#)           | Case with hood, frame and module holders | 825/543          |              |

(°) alternatives  
(#) alternatives



1

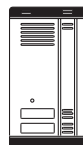

2

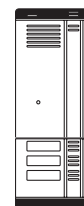

3

|                            |  |         |         |         |
|----------------------------|--|---------|---------|---------|
|                            | Loudspeaking units                       | 1035/67 | 1035/67 | 1035/67 |
|                            | Modules arranged for loudspeaking unit   | 825/16  | 825/17  | 825/15  |
|                            | Push button modules                      | -       | -       | 825/203 |
|                            | Repertory module                         | -       | -       | -       |
|                            | Conversation privacy device              | 1035/74 | 1035/74 | 1035/74 |
| FLUSH MOUNTED (#)          | Module frames with embedding box         | 825/22  | 825/22  | 825/23  |
| FLUSH-MOUNTING ACCESSORIES | Wall cover frame (°)                     | 825/32  | 825/32  | 825/33  |
|                            | Rain hood with wall cover frame (°)      | 825/42  | 825/42  | 825/43  |
| WALL MOUNTED (#)           | Case with hood, frame and module holders | 825/52  | 825/52  | 825/53  |

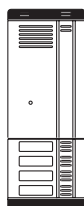

4

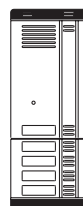

5



6

|                            |  |         |             |             |
|----------------------------|--|---------|-------------|-------------|
|                            | Loudspeaking units                       | 1035/67 | 1035/67     | 1035/67     |
|                            | Modules arranged for loudspeaking unit   | 825/15  | 825/16      | 825/17      |
|                            | Push button modules                      | 825/204 | 825/204     | 825/204     |
|                            | Repertory module                         | -       | -           | -           |
|                            | Conversation privacy device              | 1035/74 | 2 x 1035/74 | 2 x 1035/74 |
| FLUSH MOUNTED (#)          | Module frames with embedding box         | 825/23  | 825/23      | 825/23      |
| FLUSH-MOUNTING ACCESSORIES | Wall cover frame (°)                     | 825/33  | 825/33      | 825/33      |
|                            | Rain hood with wall cover frame (°)      | 825/43  | 825/43      | 825/43      |
| WALL MOUNTED (#)           | Case with hood, frame and module holders | 825/53  | 825/53      | 825/53      |



7



8



9

|                            |  |                           |             |             |
|----------------------------|--|---------------------------|-------------|-------------|
|                            | Loudspeaking units                       | 1035/67                   | 1035/67     | 1035/67     |
|                            | Modules arranged for loudspeaking unit   | 825/15                    | 825/15      | 825/16      |
|                            | Push button modules                      | 1 x 825/203 - 1 x 825/204 | 2 x 825/204 | 2 x 825/204 |
|                            | Repertory module                         | -                         | -           | -           |
|                            | Conversation privacy device              | 2 x 1035/74               | 2 x 1035/74 | 3 x 1035/74 |
| FLUSH MOUNTED (#)          | Module frames with embedding box         | 825/24                    | 825/24      | 825/24      |
| FLUSH-MOUNTING ACCESSORIES | Wall cover frame (°)                     | 825/404                   | 825/404     | 825/404     |
|                            | Rain hood with wall cover frame (°)      | 825/441                   | 825/441     | 825/441     |
| WALL MOUNTED (#)           | Case with hood, frame and module holders | 825/541                   | 825/541     | 825/541     |

(°) alternatives  
(#) alternatives



10



7

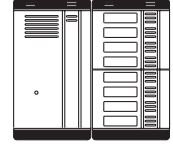

8

|                            |  |             |   |                           |   |             |   |
|----------------------------|--|-------------|---|---------------------------|---|-------------|---|
|                            | Loudspeaking units                       | 1035/67     |   | 1035/67                   |   | 1035/67     |   |
|                            | Modules arranged for loudspeaking unit   | 825/17      |   | 825/15                    |   | 825/15      |   |
|                            | Push button modules                      | 2 x 825/204 | - | 1 x 825/203 - 1 x 825/204 | - | 2 x 825/204 | - |
|                            | Conversation privacy device              | 3 x 1035/74 |   | 2 x 1035/74               |   | 2 x 1035/74 |   |
| FLUSH MOUNTED (#)          | Module frames with embedding box         | 825/24      |   | 2 x 825/22                |   | 2 x 825/22  |   |
| FLUSH-MOUNTING ACCESSORIES | Wall cover frame (°)                     | 825/404     |   | 825/34                    |   | 825/34      |   |
|                            | Rain hood with wall cover frame (°)      | 825/441     |   | 825/44                    |   | 825/44      |   |
| WALL MOUNTED (#)           | Case with hood, frame and module holders | 825/541     |   | 825/54                    |   | 825/54      |   |

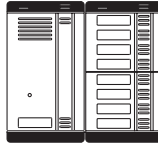

9



10

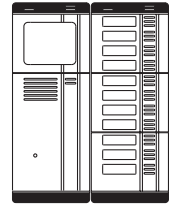

11

|                            |  |             |   |             |   |                           |       |
|----------------------------|--|-------------|---|-------------|---|---------------------------|-------|
|                            | Loudspeaking units                       | 1035/67     |   | 1035/67     |   | 1035/67                   |       |
|                            | Modules arranged for loudspeaking unit   | 825/16      |   | 825/17      |   | 825/15                    |       |
|                            | Push button modules                      | 2 x 825/204 | - | 2 x 825/204 | - | 1 x 825/203 - 2 x 825/204 | 825/5 |
|                            | Conversation privacy device              | 3 x 1035/74 |   | 3 x 1035/74 |   | 3 x 1035/74               |       |
| FLUSH MOUNTED (#)          | Module frames with embedding box         | 2 x 825/22  |   | 2 x 825/22  |   | 2 x 825/23                |       |
| FLUSH-MOUNTING ACCESSORIES | Wall cover frame (°)                     | 825/34      |   | 825/34      |   | 825/36                    |       |
|                            | Rain hood with wall cover frame (°)      | 825/44      |   | 825/44      |   | 825/46                    |       |
| WALL MOUNTED (#)           | Case with hood, frame and module holders | 825/54      |   | 825/54      |   | 825/56                    |       |

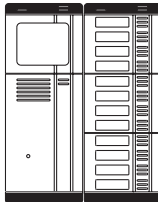

12

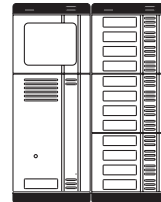

13

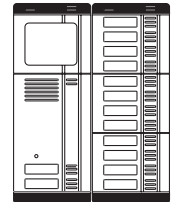

14

|                            |  |             |       |             |       |             |       |
|----------------------------|--|-------------|-------|-------------|-------|-------------|-------|
|                            | Loudspeaking units                       | 1035/67     |       | 1035/67     |       | 1035/67     |       |
|                            | Modules arranged for loudspeaking unit   | 825/15      |       | 825/16      |       | 825/17      |       |
|                            | Push button modules                      | 3 x 825/204 | 825/5 | 3 x 825/204 | 825/5 | 3 x 825/204 | 825/5 |
|                            | Conversation privacy device              | 3 x 1035/74 |       | 4 x 1035/74 |       | 4 x 1035/74 |       |
| FLUSH MOUNTED (#)          | Module frames with embedding box         | 2 x 825/23  |       | 2 x 825/23  |       | 2 x 825/23  |       |
| FLUSH-MOUNTING ACCESSORIES | Wall cover frame (°)                     | 825/36      |       | 825/36      |       | 825/36      |       |
|                            | Rain hood with wall cover frame (°)      | 825/46      |       | 825/46      |       | 825/46      |       |
| WALL MOUNTED (#)           | Case with hood, frame and module holders | 825/56      |       | 825/56      |       | 825/56      |       |

### EXAMPLES OF MODULAR CONSTRUCTIONS WITH VARIOUS CAPACITIES

(°) alternatives  
(#) alternatives

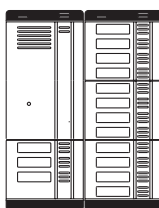

**15**

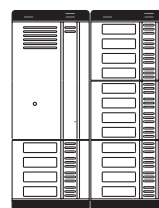

**16**

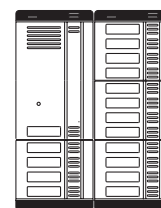

**17**

|                            |  |             |               |             |   |             |   |
|----------------------------|--|-------------|---------------|-------------|---|-------------|---|
|                            | Loudspeaking units                       | 1035/67     |               | 1035/67     |   | 1035/67     |   |
|                            | Modules arranged for loudspeaking unit   | 825/15      |               | 825/15      |   | 825/16      |   |
|                            | Push button modules                      | 1 x 825/203 | - 3 x 825/204 | 4 x 825/204 | - | 4 x 825/204 | - |
|                            | Conversation privacy device              | 4 x 1035/74 |               | 4 x 1035/74 |   | 5 x 1035/74 |   |
| FLUSH MOUNTED (#)          | Module frames with embedding box         | 2 x 825/23  |               | 2 x 825/23  |   | 2 x 825/23  |   |
| FLUSH-MOUNTING ACCESSORIES | Wall cover frame (°)                     | 825/36      |               | 825/36      |   | 825/36      |   |
|                            | Rain hood with wall cover frame (°)      | 825/46      |               | 825/46      |   | 825/46      |   |
| WALL MOUNTED (#)           | Case with hood, frame and module holders | 825/56      |               | 825/56      |   | 825/56      |   |

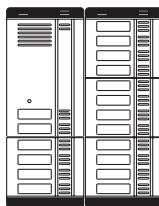

**18**

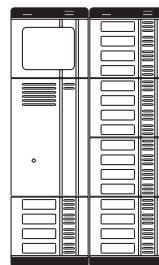

**20**

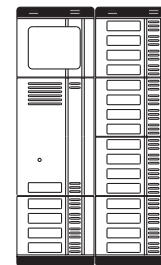

**21**

|                            |  |             |   |             |       |             |       |
|----------------------------|--|-------------|---|-------------|-------|-------------|-------|
|                            | Loudspeaking units                       | 1035/67     |   | 1035/67     |       | 1035/67     |       |
|                            | Modules arranged for loudspeaking unit   | 825/17      |   | 825/15      |       | 825/16      |       |
|                            | Push button modules                      | 4 x 825/204 | - | 5 x 825/204 | 825/5 | 5 x 825/204 | 825/5 |
|                            | Conversation privacy device              | 5 x 1035/74 |   | 5 x 1035/74 |       | 6 x 1035/74 |       |
| FLUSH MOUNTED (#)          | Module frames with embedding box         | 2 x 825/23  |   | 2 x 825/24  |       | 2 x 825/24  |       |
| FLUSH-MOUNTING ACCESSORIES | Wall cover frame (°)                     | 825/36      |   | 825/408     |       | 825/408     |       |
|                            | Rain hood with wall cover frame (°)      | 825/46      |   | 825/442     |       | 825/442     |       |
| WALL MOUNTED (#)           | Case with hood, frame and module holders | 825/56      |   | 825/542     |       | 825/542     |       |

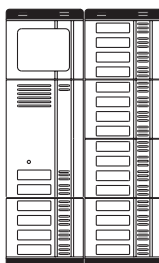

**22**

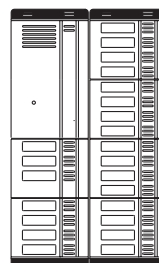

**23**

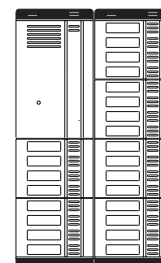

**24**

|                            |  |             |       |                           |   |             |   |
|----------------------------|--|-------------|-------|---------------------------|---|-------------|---|
|                            | Loudspeaking units                       | 1035/67     |       | 1035/67                   |   | 1035/67     |   |
|                            | Modules arranged for loudspeaking unit   | 825/17      |       | 825/15                    |   | 825/15      |   |
|                            | Push button modules                      | 5 x 825/204 | 825/5 | 1 x 825/203 - 5 x 825/204 | - | 6 x 825/204 | - |
|                            | Conversation privacy device              | 6 x 1035/74 |       | 6 x 1035/74               |   | 6 x 1035/74 |   |
| FLUSH MOUNTED (#)          | Module frames with embedding box         | 2 x 825/24  |       | 2 x 825/24                |   | 2 x 825/24  |   |
| FLUSH-MOUNTING ACCESSORIES | Wall cover frame (°)                     | 825/408     |       | 825/408                   |   | 825/408     |   |
|                            | Rain hood with wall cover frame (°)      | 825/442     |       | 825/442                   |   | 825/442     |   |
| WALL MOUNTED (#)           | Case with hood, frame and module holders | 825/542     |       | 825/542                   |   | 825/542     |   |



**EXAMPLES OF MODULAR CONSTRUCTIONS WITH VARIOUS CAPACITIES**

(°) alternatives  
(#) alternatives

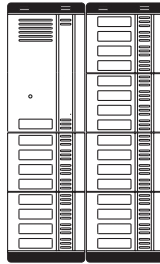

**25**

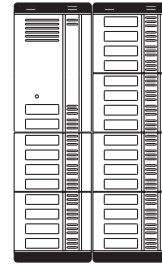

**26**

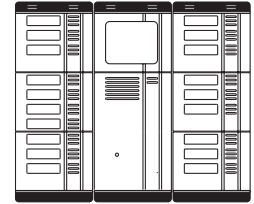

**19**

|                            |  |                  |             |             |             |             |                                 |
|----------------------------|--|------------------|-------------|-------------|-------------|-------------|---------------------------------|
|                            | Loudspeaking units                       | 1035/67          |             | 1035/67     |             | 1035/67     |                                 |
|                            | Modules arranged for loudspeaking unit   | 825/16           |             | 825/17      |             | 825/15      |                                 |
|                            | Push button modules                      | Repertory module | 6 x 825/204 | -           | 6 x 825/204 | -           | 5 x 825/203 - 1 x 825/204 825/5 |
|                            | Conversation privacy device              | 7 x 1035/74      |             | 7 x 1035/74 |             | 6 x 1035/74 |                                 |
| FLUSH MOUNTED (#)          | Module frames with embedding box         | 2 x 825/24       |             | 2 x 825/24  |             | 3 x 825/23  |                                 |
| FLUSH-MOUNTING ACCESSORIES | Wall cover frame (°)                     | 825/408          |             | 825/408     |             | 825/39      |                                 |
|                            | Rain hood with wall cover frame (°)      | 825/442          |             | 825/442     |             | 825/49      |                                 |
| WALL MOUNTED (#)           | Case with hood, frame and module holders | 825/542          |             | 825/542     |             | 825/59      |                                 |

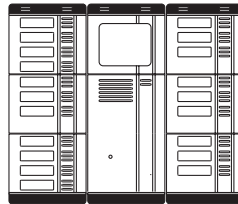

**20**

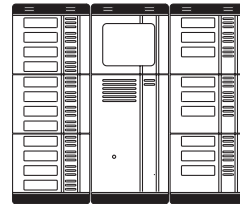

**21**

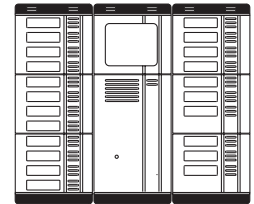

**22**

|                            |  |                  |                                 |                                 |                                 |             |  |
|----------------------------|--|------------------|---------------------------------|---------------------------------|---------------------------------|-------------|--|
|                            | Loudspeaking units                       | 1035/67          |                                 | 1035/67                         |                                 | 1035/67     |  |
|                            | Modules arranged for loudspeaking unit   | 825/15           |                                 | 825/15                          |                                 | 825/15      |  |
|                            | Push button modules                      | Repertory module | 4 x 825/203 - 2 x 825/204 825/5 | 3 x 825/203 - 3 x 825/204 825/5 | 2 x 825/203 - 4 x 825/204 825/5 |             |  |
|                            | Conversation privacy device              | 6 x 1035/74      |                                 | 6 x 1035/74                     |                                 | 6 x 1035/74 |  |
| FLUSH MOUNTED (#)          | Module frames with embedding box         | 3 x 825/23       |                                 | 3 x 825/23                      |                                 | 3 x 825/23  |  |
| FLUSH-MOUNTING ACCESSORIES | Wall cover frame (°)                     | 825/39           |                                 | 825/39                          |                                 | 825/39      |  |
|                            | Rain hood with wall cover frame (°)      | 825/49           |                                 | 825/49                          |                                 | 825/49      |  |
| WALL MOUNTED (#)           | Case with hood, frame and module holders | 825/59           |                                 | 825/59                          |                                 | 825/59      |  |

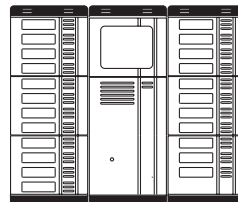

**23**

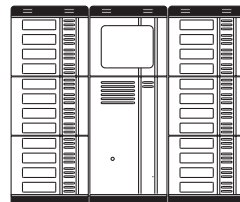

**24**

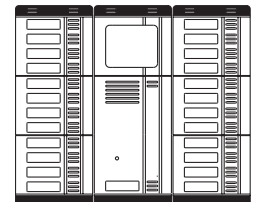

**25**

|                            |  |                  |                                 |                   |                   |             |  |
|----------------------------|--|------------------|---------------------------------|-------------------|-------------------|-------------|--|
|                            | Loudspeaking units                       | 1035/67          |                                 | 1035/67           |                   | 1035/67     |  |
|                            | Modules arranged for loudspeaking unit   | 825/15           |                                 | 825/15            |                   | 825/16      |  |
|                            | Push button modules                      | Repertory module | 1 x 825/203 - 5 x 825/204 825/5 | 6 x 825/204 825/5 | 6 x 825/204 825/5 |             |  |
|                            | Conversation privacy device              | 6 x 1035/74      |                                 | 6 x 1035/74       |                   | 7 x 1035/74 |  |
| FLUSH MOUNTED (#)          | Module frames with embedding box         | 3 x 825/23       |                                 | 3 x 825/23        |                   | 3 x 825/23  |  |
| FLUSH-MOUNTING ACCESSORIES | Wall cover frame (°)                     | 825/39           |                                 | 825/39            |                   | 825/39      |  |
|                            | Rain hood with wall cover frame (°)      | 825/49           |                                 | 825/49            |                   | 825/49      |  |
| WALL MOUNTED (#)           | Case with hood, frame and module holders | 825/59           |                                 | 825/59            |                   | 825/59      |  |

### EXAMPLES OF MODULAR CONSTRUCTIONS WITH VARIOUS CAPACITIES

(°) alternatives  
(#) alternatives

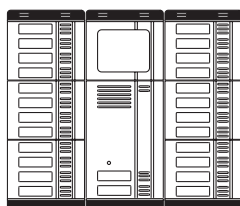

**26**



**27**



**28**

|                            |  |             |       |                           |   |             |   |
|----------------------------|--|-------------|-------|---------------------------|---|-------------|---|
| FLUSH MOUNTED (#)          | Loudspeaking units                       | 1035/67     |       | 1035/67                   |   | 1035/67     |   |
|                            | Modules arranged for loudspeaking unit   | 825/17      |       | 825/15                    |   | 825/15      |   |
|                            | Push button modules                      | 6 x 825/204 | 825/5 | 1 x 825/203 - 6 x 825/204 | - | 7 x 825/204 | - |
|                            | Conversation privacy device              | 7 x 1035/74 |       | 7 x 1035/74               |   | 7 x 1035/74 |   |
| FLUSH-MOUNTING ACCESSORIES | Wall cover frame (°)                     | 825/39      |       | 825/39                    |   | 825/39      |   |
|                            | Rain hood with wall cover frame (°)      | 825/49      |       | 825/49                    |   | 825/49      |   |
| WALL MOUNTED (#)           | Case with hood, frame and module holders | 825/59      |       | 825/59                    |   | 825/59      |   |

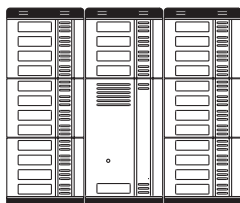

**29**

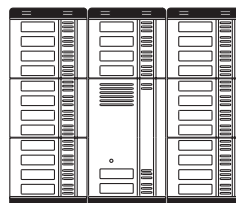

**30**

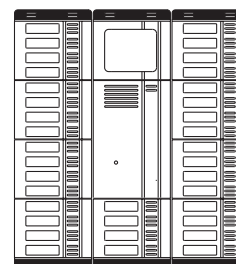

**36**

|                            |  |             |   |             |   |             |       |
|----------------------------|--|-------------|---|-------------|---|-------------|-------|
| FLUSH MOUNTED (#)          | Loudspeaking units                       | 1035/67     |   | 1035/67     |   | 1035/67     |       |
|                            | Modules arranged for loudspeaking unit   | 825/16      |   | 825/17      |   | 825/15      |       |
|                            | Push button modules                      | 7 x 825/204 | - | 7 x 825/204 | - | 9 x 825/204 | 825/5 |
|                            | Conversation privacy device              | 8 x 1035/74 |   | 8 x 1035/74 |   | 9 x 1035/74 |       |
| FLUSH-MOUNTING ACCESSORIES | Wall cover frame (°)                     | 825/39      |   | 825/39      |   | 825/412     |       |
|                            | Rain hood with wall cover frame (°)      | 825/49      |   | 825/49      |   | 825/443     |       |
| WALL MOUNTED (#)           | Case with hood, frame and module holders | 825/59      |   | 825/59      |   | 825/543     |       |

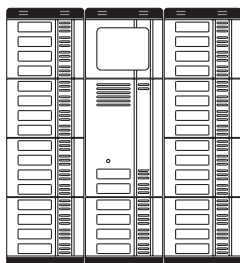

**38**

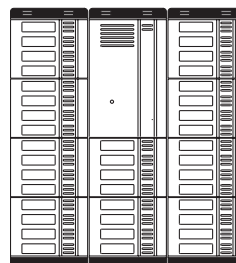

**40**

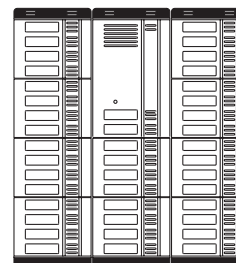

**42**

|                            |  |              |       |              |   |              |   |
|----------------------------|--|--------------|-------|--------------|---|--------------|---|
| FLUSH MOUNTED (#)          | Loudspeaking units                       | 1035/67      |       | 1035/67      |   | 1035/67      |   |
|                            | Modules arranged for loudspeaking unit   | 825/17       |       | 825/15       |   | 825/17       |   |
|                            | Push button modules                      | 9 x 825/204  | 825/5 | 10 x 825/204 | - | 10 x 825/204 | - |
|                            | Conversation privacy device              | 10 x 1035/74 |       | 10 x 1035/74 |   | 11 x 1035/74 |   |
| FLUSH-MOUNTING ACCESSORIES | Wall cover frame (°)                     | 825/412      |       | 825/412      |   | 825/412      |   |
|                            | Rain hood with wall cover frame (°)      | 825/443      |       | 825/443      |   | 825/443      |   |
| WALL MOUNTED (#)           | Case with hood, frame and module holders | 825/543      |       | 825/543      |   | 825/543      |   |

**EXAMPLES OF MODULAR CONSTRUCTIONS WITH VARIOUS CAPACITIES**

(°) alternatives  
(#) alternatives



1



2



3

|                            |  |                  |         |         |
|----------------------------|--|------------------|---------|---------|
|                            | Camera unit module                       | 825/70           | 825/70  | 825/70  |
|                            | Loudspeaking units                       | 824/500          | 824/500 | 824/500 |
|                            | Modules arranged for loudspeaking unit   | 825/211          | 825/212 | 825/210 |
|                            | Push button modules                      | Repertory module | -       | -       |
|                            |  |                  | 825/203 | -       |
| FLUSH MOUNTED (#)          | Module frames with embedding box         | 825/22           | 825/22  | 825/23  |
| FLUSH-MOUNTING ACCESSORIES | Wall cover frame (°)                     | 825/32           | 825/32  | 825/33  |
|                            | Rain hood with wall cover frame (°)      | 825/42           | 825/42  | 825/43  |
| WALL MOUNTED (#)           | Case with hood, frame and module holders | 825/52           | 825/52  | 825/53  |

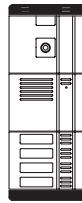

4



5

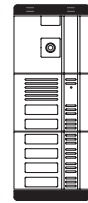

6

|                            |  |                  |         |         |
|----------------------------|--|------------------|---------|---------|
|                            | Camera unit module                       | 825/70           | 825/70  | 825/70  |
|                            | Loudspeaking units                       | 824/500          | 824/500 | 824/500 |
|                            | Modules arranged for loudspeaking unit   | 825/210          | 825/211 | 825/212 |
|                            | Push button modules                      | Repertory module | 825/204 | -       |
|                            |  |                  | 825/204 | -       |
| FLUSH MOUNTED (#)          | Module frames with embedding box         | 825/23           | 825/23  | 825/23  |
| FLUSH-MOUNTING ACCESSORIES | Wall cover frame (°)                     | 825/33           | 825/33  | 825/33  |
|                            | Rain hood with wall cover frame (°)      | 825/43           | 825/43  | 825/43  |
| WALL MOUNTED (#)           | Case with hood, frame and module holders | 825/53           | 825/53  | 825/53  |

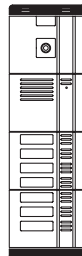

7



8

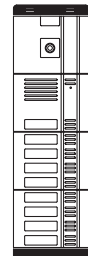

9

|                            |  |                  |                           |         |
|----------------------------|--|------------------|---------------------------|---------|
|                            | Camera unit module                       | 825/70           | 825/70                    | 825/70  |
|                            | Loudspeaking units                       | 824/500          | 824/500                   | 824/500 |
|                            | Modules arranged for loudspeaking unit   | 825/210          | 825/210                   | 825/211 |
|                            | Push button modules                      | Repertory module | 1 x 825/203 - 1 x 825/204 | -       |
|                            |  |                  | 2 x 825/204               | -       |
|                            |  |                  | 2 x 825/204               | -       |
| FLUSH MOUNTED (#)          | Module frames with embedding box         | 825/24           | 825/24                    | 825/24  |
| FLUSH-MOUNTING ACCESSORIES | Wall cover frame (°)                     | 825/404          | 825/404                   | 825/404 |
|                            | Rain hood with wall cover frame (°)      | 825/441          | 825/441                   | 825/441 |
| WALL MOUNTED (#)           | Case with hood, frame and module holders | 825/541          | 825/541                   | 825/541 |

### EXAMPLES OF MODULAR CONSTRUCTIONS WITH VARIOUS CAPACITIES

(°) alternatives  
(#) alternatives

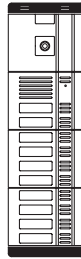

**10**



**7**

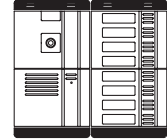

**8**

|                            |  |                  |             |            |                           |            |             |
|----------------------------|--|------------------|-------------|------------|---------------------------|------------|-------------|
|                            | Camera unit module                       | 825/70           |             | 825/70     |                           | 825/70     |             |
|                            | Loudspeaking units                       | 824/500          |             | 824/500    |                           | 824/500    |             |
|                            | Modules arranged for loudspeaking unit   | 825/212          |             | 825/210    |                           | 825/210    |             |
|                            | Push button modules                      | Repertory module | 2 x 825/204 | -          | 1 x 825/203 - 1 x 825/204 | -          | 2 x 825/204 |
| FLUSH MOUNTED (#)          | Module frames with embedding box         | 825/24           |             | 2 x 825/22 |                           | 2 x 825/23 |             |
| FLUSH-MOUNTING ACCESSORIES | Wall cover frame (°)                     | 825/404          |             | 825/34     |                           | 825/34     |             |
|                            | Rain hood with wall cover frame (°)      | 825/441          |             | 825/44     |                           | 825/44     |             |
| WALL MOUNTED (#)           | Case with hood, frame and module holders | 825/541          |             | 825/54     |                           | 825/54     |             |

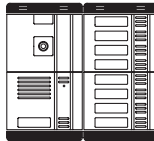

**9**

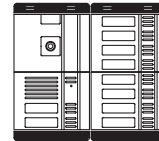

**10**

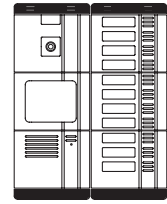

**11**

|                            |  |                  |             |            |             |            |                           |
|----------------------------|--|------------------|-------------|------------|-------------|------------|---------------------------|
|                            | Camera unit module                       | 825/70           |             | 825/70     |             | 825/70     |                           |
|                            | Loudspeaking units                       | 824/500          |             | 824/500    |             | 824/500    |                           |
|                            | Modules arranged for loudspeaking unit   | 825/211          |             | 825/212    |             | 825/210    |                           |
|                            | Push button modules                      | Repertory module | 2 x 825/204 | -          | 2 x 825/204 | -          | 1 x 825/203 - 2 x 825/204 |
| FLUSH MOUNTED (#)          | Module frames with embedding box         | 2 x 825/22       |             | 2 x 825/22 |             | 2 x 825/23 |                           |
| FLUSH-MOUNTING ACCESSORIES | Wall cover frame (°)                     | 825/34           |             | 825/34     |             | 825/36     |                           |
|                            | Rain hood with wall cover frame (°)      | 825/44           |             | 825/44     |             | 825/46     |                           |
| WALL MOUNTED (#)           | Case with hood, frame and module holders | 825/54           |             | 825/54     |             | 825/56     |                           |

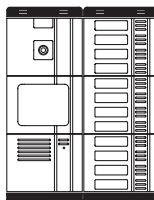

**12**

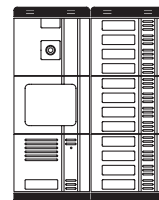

**13**

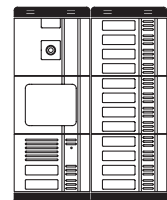

**14**

|                            |  |                  |             |            |             |            |             |
|----------------------------|--|------------------|-------------|------------|-------------|------------|-------------|
|                            | Camera unit module                       | 825/70           |             | 825/70     |             | 825/70     |             |
|                            | Loudspeaking units                       | 824/500          |             | 824/500    |             | 824/500    |             |
|                            | Modules arranged for loudspeaking unit   | 825/210          |             | 825/211    |             | 825/212    |             |
|                            | Push button modules                      | Repertory module | 3 x 825/204 | 1 x 825/5  | 3 x 825/204 | 1 x 825/5  | 3 x 825/204 |
| FLUSH MOUNTED (#)          | Module frames with embedding box         | 2 x 825/23       |             | 2 x 825/23 |             | 2 x 825/23 |             |
| FLUSH-MOUNTING ACCESSORIES | Wall cover frame (°)                     | 825/36           |             | 825/36     |             | 825/36     |             |
|                            | Rain hood with wall cover frame (°)      | 825/46           |             | 825/46     |             | 825/46     |             |
| WALL MOUNTED (#)           | Case with hood, frame and module holders | 825/56           |             | 825/56     |             | 825/56     |             |

**EXAMPLES OF MODULAR CONSTRUCTIONS WITH VARIOUS CAPACITIES**

(°) alternatives  
(#) alternatives

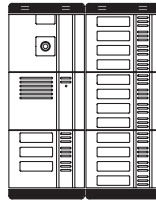

**15**



**16**

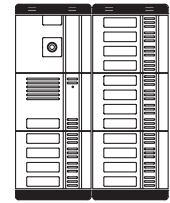

**17**

|                            |  |                           |             |             |
|----------------------------|--|---------------------------|-------------|-------------|
|                            | Camera unit module                       | 825/70                    | 825/70      | 825/70      |
|                            | Loudspeaking units                       | 824/500                   | 824/500     | 824/500     |
|                            | Modules arranged for loudspeaking unit   | 825/210                   | 825/210     | 825/211     |
|                            | Push button modules                      | 1 x 825/203 - 3 x 825/204 | -           | 4 x 825/204 |
|                            | Repertory module                         | -                         | 4 x 825/204 | -           |
| FLUSH MOUNTED (#)          | Module frames with embedding box         | 2 x 825/23                | 2 x 825/23  | 2 x 825/23  |
| FLUSH-MOUNTING ACCESSORIES | Wall cover frame (°)                     | 825/36                    | 825/36      | 825/36      |
|                            | Rain hood with wall cover frame (°)      | 825/46                    | 825/46      | 825/46      |
| WALL MOUNTED (#)           | Case with hood, frame and module holders | 825/56                    | 825/56      | 825/56      |

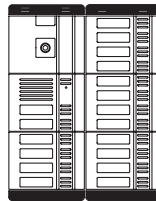

**18**

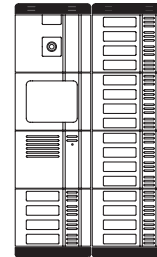

**20**

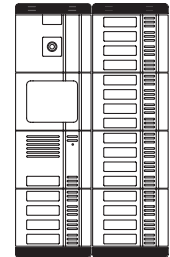

**21**

|                            |  |             |            |             |
|----------------------------|--|-------------|------------|-------------|
|                            | Camera unit module                       | 825/70      | 825/70     | 825/70      |
|                            | Loudspeaking units                       | 824/500     | 824/500    | 824/500     |
|                            | Modules arranged for loudspeaking unit   | 825/212     | 825/210    | 825/211     |
|                            | Push button modules                      | 4 x 825/204 | -          | 5 x 825/204 |
|                            | Repertory module                         | -           | 1 x 825/5  | 1 x 825/5   |
| FLUSH MOUNTED (#)          | Module frames with embedding box         | 2 x 825/23  | 2 x 825/24 | 2 x 825/24  |
| FLUSH-MOUNTING ACCESSORIES | Wall cover frame (°)                     | 825/36      | 825/408    | 825/408     |
|                            | Rain hood with wall cover frame (°)      | 825/46      | 825/442    | 825/442     |
| WALL MOUNTED (#)           | Case with hood, frame and module holders | 825/56      | 825/542    | 825/542     |

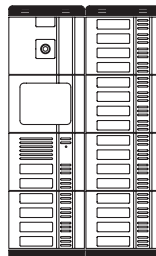

**22**

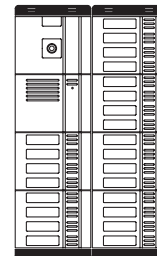

**24**

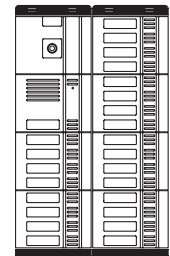

**25**

|                            |  |             |            |             |
|----------------------------|--|-------------|------------|-------------|
|                            | Camera unit module                       | 825/70      | 825/70     | 825/70      |
|                            | Loudspeaking units                       | 824/500     | 824/500    | 824/500     |
|                            | Modules arranged for loudspeaking unit   | 825/212     | 825/210    | 825/211     |
|                            | Push button modules                      | 5 x 825/204 | -          | 6 x 825/204 |
|                            | Repertory module                         | 1 x 825/5   | -          | -           |
| FLUSH MOUNTED (#)          | Module frames with embedding box         | 2 x 825/24  | 2 x 825/24 | 2 x 825/24  |
| FLUSH-MOUNTING ACCESSORIES | Wall cover frame (°)                     | 825/408     | 825/408    | 825/408     |
|                            | Rain hood with wall cover frame (°)      | 825/442     | 825/442    | 825/442     |
| WALL MOUNTED (#)           | Case with hood, frame and module holders | 825/542     | 825/542    | 825/542     |

### EXAMPLES OF MODULAR CONSTRUCTIONS WITH VARIOUS CAPACITIES

(°) alternatives  
(#) alternatives

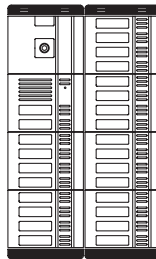

**26**

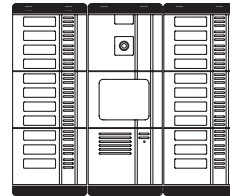

**22**

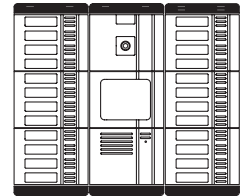

**24**

|                            |  |                  |             |            |                           |            |                         |
|----------------------------|--|------------------|-------------|------------|---------------------------|------------|-------------------------|
|                            | Camera unit module                       | 825/70           |             | 825/70     |                           | 825/70     |                         |
|                            | Loudspeaking units                       | 824/500          |             | 824/500    |                           | 824/500    |                         |
|                            | Modules arranged for loudspeaking unit   | 825/212          |             | 825/210    |                           | 825/210    |                         |
|                            | Push button modules                      | Repertory module | 6 x 825/204 | -          | 2 x 825/203 - 4 x 825/204 | 1 x 825/5  | 6 x 825/204   1 x 825/5 |
| FLUSH MOUNTED (#)          | Module frames with embedding box         | 2 x 825/24       |             | 3 x 825/23 |                           | 3 x 825/23 |                         |
| FLUSH-MOUNTING ACCESSORIES | Wall cover frame (°)                     | 825/408          |             | 825/39     |                           | 825/39     |                         |
|                            | Rain hood with wall cover frame (°)      | 825/442          |             | 825/49     |                           | 825/49     |                         |
| WALL MOUNTED (#)           | Case with hood, frame and module holders | 825/542          |             | 825/59     |                           | 825/59     |                         |

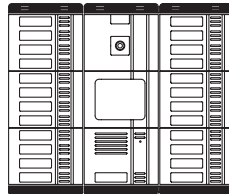

**25**

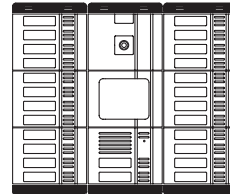

**26**

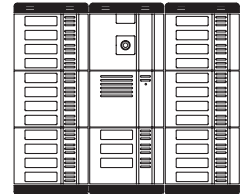

**27**

|                            |  |                  |             |            |             |            |                               |
|----------------------------|--|------------------|-------------|------------|-------------|------------|-------------------------------|
|                            | Camera unit module                       | 825/70           |             | 825/70     |             | 825/70     |                               |
|                            | Loudspeaking units                       | 824/500          |             | 824/500    |             | 824/500    |                               |
|                            | Modules arranged for loudspeaking unit   | 825/211          |             | 825/212    |             | 825/210    |                               |
|                            | Push button modules                      | Repertory module | 6 x 825/204 | 1 x 825/5  | 6 x 825/204 | 1 x 825/5  | 1 x 825/203 - 6 x 825/204   - |
| FLUSH MOUNTED (#)          | Module frames with embedding box         | 3 x 825/23       |             | 3 x 825/23 |             | 3 x 825/23 |                               |
| FLUSH-MOUNTING ACCESSORIES | Wall cover frame (°)                     | 825/39           |             | 825/39     |             | 825/39     |                               |
|                            | Rain hood with wall cover frame (°)      | 825/49           |             | 825/49     |             | 825/49     |                               |
| WALL MOUNTED (#)           | Case with hood, frame and module holders | 825/59           |             | 825/59     |             | 825/59     |                               |

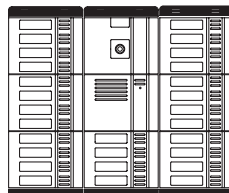

**28**

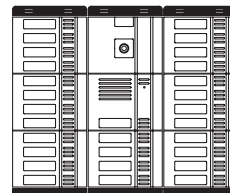

**29**

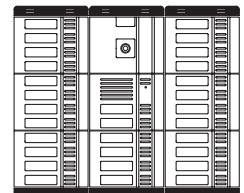

**30**

|                            |  |                  |             |            |             |            |                 |
|----------------------------|--|------------------|-------------|------------|-------------|------------|-----------------|
|                            | Camera unit module                       | 825/70           |             | 825/70     |             | 825/70     |                 |
|                            | Loudspeaking units                       | 824/500          |             | 824/500    |             | 824/500    |                 |
|                            | Modules arranged for loudspeaking unit   | 825/210          |             | 825/211    |             | 825/212    |                 |
|                            | Push button modules                      | Repertory module | 7 x 825/204 | -          | 7 x 825/204 | -          | 7 x 825/204   - |
| FLUSH MOUNTED (#)          | Module frames with embedding box         | 3 x 825/23       |             | 3 x 825/23 |             | 3 x 825/23 |                 |
| FLUSH-MOUNTING ACCESSORIES | Wall cover frame (°)                     | 825/39           |             | 825/39     |             | 825/39     |                 |
|                            | Rain hood with wall cover frame (°)      | 825/49           |             | 825/49     |             | 825/49     |                 |
| WALL MOUNTED (#)           | Case with hood, frame and module holders | 825/59           |             | 825/59     |             | 825/59     |                 |

**EXAMPLES OF MODULAR CONSTRUCTIONS WITH VARIOUS CAPACITIES**

(°) alternatives  
(#) alternatives

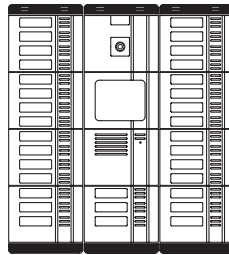

**33**

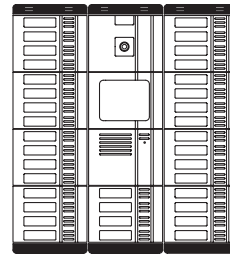

**36**

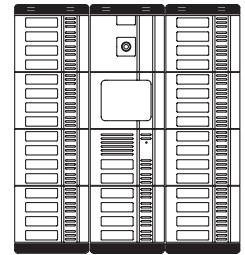

**38**

|                            |  |                  |                           |            |             |            |             |
|----------------------------|--|------------------|---------------------------|------------|-------------|------------|-------------|
|                            | Camera unit module                       | 825/70           |                           | 825/70     |             | 825/70     |             |
|                            | Loudspeaking units                       | 824/500          |                           | 824/500    |             | 824/500    |             |
|                            | Modules arranged for loudspeaking unit   | 825/210          |                           | 825/210    |             | 825/212    |             |
|                            | Push button modules                      | Repertory module | 3 x 825/203 - 6 x 825/204 | 1 x 825/5  | 9 x 825/204 | 1 x 825/5  | 9 x 825/204 |
| FLUSH MOUNTED (#)          | Module frames with embedding box         | 3 x 825/24       |                           | 3 x 825/24 |             | 3 x 825/24 |             |
| FLUSH-MOUNTING ACCESSORIES | Wall cover frame (°)                     | 825/412          |                           | 825/412    |             | 825/412    |             |
|                            | Rain hood with wall cover frame (°)      | 825/443          |                           | 825/443    |             | 825/443    |             |
| WALL MOUNTED (#)           | Case with hood, frame and module holders | 825/543          |                           | 825/543    |             | 825/543    |             |

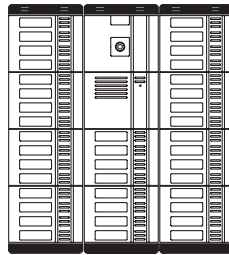

**40**

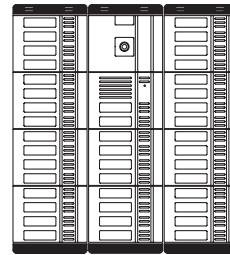

**42**

|                            |  |                  |              |            |              |
|----------------------------|--|------------------|--------------|------------|--------------|
|                            | Camera unit module                       | 825/70           |              | 825/70     |              |
|                            | Loudspeaking units                       | 824/500          |              | 824/500    |              |
|                            | Modules arranged for loudspeaking unit   | 825/210          |              | 825/212    |              |
|                            | Push button modules                      | Repertory module | 10 x 825/204 | -          | 10 x 825/204 |
| FLUSH MOUNTED (#)          | Module frames with embedding box         | 3 x 825/24       |              | 3 x 825/24 |              |
| FLUSH-MOUNTING ACCESSORIES | Wall cover frame (°)                     | 825/412          |              | 825/412    |              |
|                            | Rain hood with wall cover frame (°)      | 825/443          |              | 825/443    |              |
| WALL MOUNTED (#)           | Case with hood, frame and module holders | 825/543          |              | 825/543    |              |



(°) alternatives  
(#) alternatives

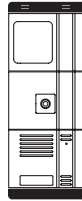

1



2



3

|                            |  |                  |         |         |
|----------------------------|--|------------------|---------|---------|
|                            | Camera unit module                       | 1855/70          | 1855/70 | 1855/70 |
|                            | Loudspeaking units                       | 824/500          | 824/500 | 824/500 |
|                            | Modules arranged for loudspeaking unit   | 825/211          | 825/212 | 825/210 |
|                            | Button module                            | -                | -       | 825/203 |
|                            | Lighting module                          | 1855/50          | 1855/50 | 1855/50 |
|                            | Push button modules                      | Repertory module | -       | -       |
| FLUSH MOUNTED (#)          | Module frames with embedding box         | 825/23           | 825/23  | 825/24  |
| FLUSH-MOUNTING ACCESSORIES | Wall cover frame (°)                     | 825/33           | 825/33  | 825/404 |
|                            | Rain hood with wall cover frame (°)      | 825/43           | 825/43  | 825/441 |
| WALL MOUNTED (#)           | Case with hood, frame and module holders | 825/53           | 825/53  | 825/541 |

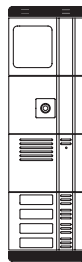

4



5



6

|                            |  |                  |         |         |
|----------------------------|--|------------------|---------|---------|
|                            | Camera unit module                       | 1855/70          | 1855/70 | 1855/70 |
|                            | Loudspeaking units                       | 824/500          | 824/500 | 824/500 |
|                            | Modules arranged for loudspeaking unit   | 825/210          | 825/211 | 825/212 |
|                            | Button module                            | 825/204          | 825/204 | 825/204 |
|                            | Lighting module                          | 1855/50          | 1855/50 | 1855/50 |
|                            | Push button modules                      | Repertory module | -       | -       |
| FLUSH MOUNTED (#)          | Module frames with embedding box         | 825/24           | 825/24  | 825/24  |
| FLUSH-MOUNTING ACCESSORIES | Wall cover frame (°)                     | 825/404          | 825/404 | 825/404 |
|                            | Rain hood with wall cover frame (°)      | 825/441          | 825/441 | 825/441 |
| WALL MOUNTED (#)           | Case with hood, frame and module holders | 825/541          | 825/541 | 825/541 |

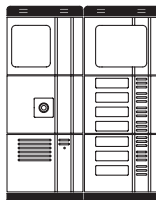

7

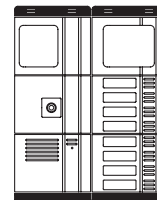

8

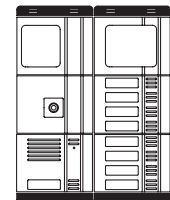

9

|                            |  |                           |             |             |
|----------------------------|--|---------------------------|-------------|-------------|
|                            | Camera unit module                       | 1855/70                   | 1855/70     | 1855/70     |
|                            | Loudspeaking units                       | 824/500                   | 824/500     | 824/500     |
|                            | Modules arranged for loudspeaking unit   | 825/210                   | 825/210     | 825/211     |
|                            | Button module                            | 1 x 825/203 - 1 x 825/204 | 2 x 825/204 | 2 x 825/204 |
|                            | Lighting module                          | 1855/50                   | 1855/50     | 1855/50     |
|                            | Push button modules                      | Repertory module          | -           | 825/5       |
| FLUSH MOUNTED (#)          | Module frames with embedding box         | 2 x 825/23                | 2 x 825/23  | 2 x 825/23  |
| FLUSH-MOUNTING ACCESSORIES | Wall cover frame (°)                     | 825/36                    | 825/36      | 825/36      |
|                            | Rain hood with wall cover frame (°)      | 825/46                    | 825/46      | 825/46      |
| WALL MOUNTED (#)           | Case with hood, frame and module holders | 825/56                    | 825/56      | 825/56      |

(°) alternatives  
(#) alternatives

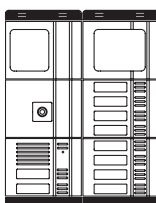

10

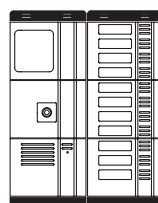

11

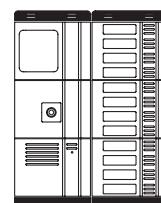

12

|                            |  |                  |                           |             |   |   |   |
|----------------------------|--|------------------|---------------------------|-------------|---|---|---|
|                            | Camera unit module                       | 1855/70          | 1855/70                   | 1855/70     |   |   |   |
|                            | Loudspeaking units                       | 824/500          | 824/500                   | 824/500     |   |   |   |
|                            | Modules arranged for loudspeaking unit   | 825/212          | 825/210                   | 825/210     |   |   |   |
|                            | Button module                            | 2 x 825/204      | 1 x 825/203 - 2 x 825/204 | 3 x 825/204 |   |   |   |
|                            | Lighting module                          | 1855/50          | 1855/50                   | 1855/50     |   |   |   |
|                            | Push button modules                      | Repertory module | -                         | 825/5       | - | - | - |
| FLUSH MOUNTED (#)          | Module frames with embedding box         | 2 x 825/23       | 2 x 825/23                | 2 x 825/23  |   |   |   |
| FLUSH-MOUNTING ACCESSORIES | Wall cover frame (°)                     | 825/36           | 825/36                    | 825/36      |   |   |   |
|                            | Rain hood with wall cover frame (°)      | 825/46           | 825/46                    | 825/46      |   |   |   |
| WALL MOUNTED (#)           | Case with hood, frame and module holders | 825/56           | 825/56                    | 825/56      |   |   |   |

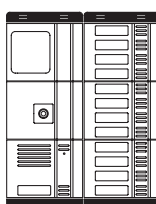

13

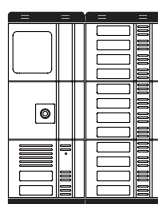

14

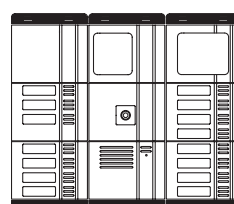

15

|                            |  |                  |             |                           |   |   |
|----------------------------|--|------------------|-------------|---------------------------|---|---|
|                            | Camera unit module                       | 1855/70          | 1855/70     | 1855/70                   |   |   |
|                            | Loudspeaking units                       | 824/500          | 824/500     | 824/500                   |   |   |
|                            | Modules arranged for loudspeaking unit   | 825/211          | 825/212     | 825/210                   |   |   |
|                            | Button module                            | 3 x 825/204      | 3 x 825/204 | 1 x 825/203 - 3 x 825/204 |   |   |
|                            | Lighting module                          | 1855/50          | 1855/50     | 1855/50                   |   |   |
|                            | Push button modules                      | Repertory module | -           | -                         | - | - |
| FLUSH MOUNTED (#)          | Module frames with embedding box         | 2 x 825/23       | 2 x 825/23  | 3 x 825/23                |   |   |
| FLUSH-MOUNTING ACCESSORIES | Wall cover frame (°)                     | 825/36           | 825/36      | 825/39                    |   |   |
|                            | Rain hood with wall cover frame (°)      | 825/46           | 825/46      | 825/49                    |   |   |
| WALL MOUNTED (#)           | Case with hood, frame and module holders | 825/56           | 825/56      | 825/59                    |   |   |

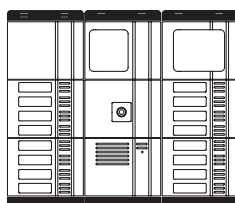

16

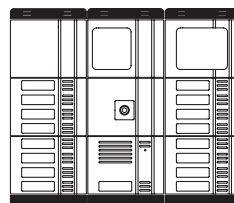

17

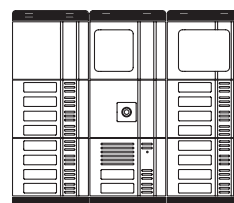

18

|                            |  |                  |             |             |       |       |       |
|----------------------------|--|------------------|-------------|-------------|-------|-------|-------|
|                            | Camera unit module                       | 1855/70          | 1855/70     | 1855/70     |       |       |       |
|                            | Loudspeaking units                       | 824/500          | 824/500     | 824/500     |       |       |       |
|                            | Modules arranged for loudspeaking unit   | 825/210          | 825/211     | 825/212     |       |       |       |
|                            | Button module                            | 4 x 825/204      | 4 x 825/204 | 4 x 825/204 |       |       |       |
|                            | Lighting module                          | 1855/50          | 1855/50     | 1855/50     |       |       |       |
|                            | Push button modules                      | Repertory module | 825/9       | 825/5       | 825/9 | 825/5 | 825/9 |
| FLUSH MOUNTED (#)          | Module frames with embedding box         | 3 x 825/23       | 3 x 825/23  | 3 x 825/23  |       |       |       |
| FLUSH-MOUNTING ACCESSORIES | Wall cover frame (°)                     | 825/39           | 825/39      | 825/39      |       |       |       |
|                            | Rain hood with wall cover frame (°)      | 825/49           | 825/49      | 825/49      |       |       |       |
| WALL MOUNTED (#)           | Case with hood, frame and module holders | 825/59           | 825/59      | 825/59      |       |       |       |

### EXAMPLES OF MODULAR CONSTRUCTIONS WITH VARIOUS CAPACITIES

(°) alternatives  
(#) alternatives

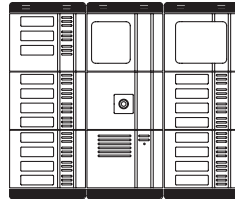

**19**

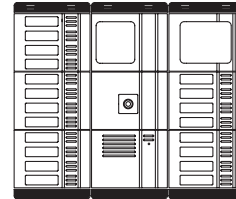

**20**

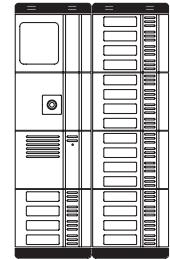

**20**

|                            |  |                           |             |             |   |       |   |
|----------------------------|--|---------------------------|-------------|-------------|---|-------|---|
|                            | Camera unit module                       | 1855/70                   | 1855/70     | 1855/70     |   |       |   |
|                            | Loudspeaking units                       | 824/500                   | 824/500     | 824/500     |   |       |   |
|                            | Modules arranged for loudspeaking unit   | 825/210                   | 825/210     | 825/210     |   |       |   |
|                            | Button module                            | 1 x 825/203 - 4 x 825/204 | 5 x 825/204 | 5 x 825/204 |   |       |   |
|                            | Lighting module                          | 1855/50                   | 1855/50     | 1855/50     |   |       |   |
|                            | Push button modules                      | Repertory module          | -           | 825/5       | - | 825/5 | - |
| FLUSH MOUNTED (#)          | Module frames with embedding box         | 3 x 825/23                | 3 x 825/23  | 2 x 825/24  |   |       |   |
| FLUSH-MOUNTING ACCESSORIES | Wall cover frame (°)                     | 825/39                    | 825/39      | 825/408     |   |       |   |
|                            | Rain hood with wall cover frame (°)      | 825/49                    | 825/49      | 825/442     |   |       |   |
| WALL MOUNTED (#)           | Case with hood, frame and module holders | 825/59                    | 825/59      | 825/542     |   |       |   |

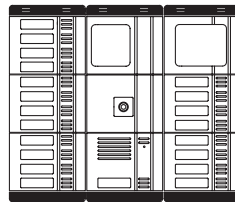

**21**

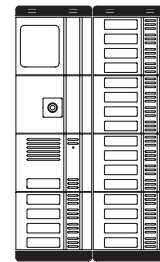

**21**

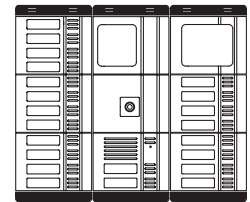

**22**

|                            |  |                  |             |             |   |   |   |
|----------------------------|--|------------------|-------------|-------------|---|---|---|
|                            | Camera unit module                       | 1855/70          | 1855/70     | 1855/70     |   |   |   |
|                            | Loudspeaking units                       | 824/500          | 824/500     | 824/500     |   |   |   |
|                            | Modules arranged for loudspeaking unit   | 825/211          | 825/211     | 825/212     |   |   |   |
|                            | Button module                            | 5 x 825/204      | 5 x 825/204 | 5 x 825/204 |   |   |   |
|                            | Lighting module                          | 1855/50          | 1855/50     | 1855/50     |   |   |   |
|                            | Push button modules                      | Repertory module | -           | 825/5       | - | - | - |
| FLUSH MOUNTED (#)          | Module frames with embedding box         | 3 x 825/23       | 2 x 825/24  | 3 x 825/23  |   |   |   |
| FLUSH-MOUNTING ACCESSORIES | Wall cover frame (°)                     | 825/39           | 825/408     | 825/39      |   |   |   |
|                            | Rain hood with wall cover frame (°)      | 825/49           | 825/442     | 825/49      |   |   |   |
| WALL MOUNTED (#)           | Case with hood, frame and module holders | 825/59           | 825/542     | 825/59      |   |   |   |

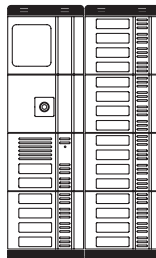

**22**

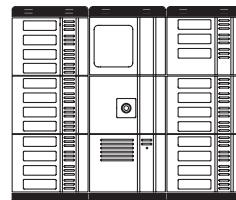

**23**

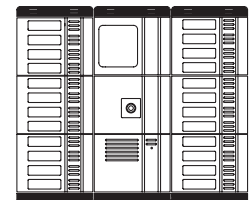

**24**

|                            |  |                  |                           |             |   |   |   |
|----------------------------|--|------------------|---------------------------|-------------|---|---|---|
|                            | Camera unit module                       | 1855/70          | 1855/70                   | 1855/70     |   |   |   |
|                            | Loudspeaking units                       | 824/500          | 824/500                   | 824/500     |   |   |   |
|                            | Modules arranged for loudspeaking unit   | 825/212          | 825/210                   | 825/210     |   |   |   |
|                            | Button module                            | 5 x 825/204      | 1 x 825/203 - 5 x 825/204 | 6 x 825/204 |   |   |   |
|                            | Lighting module                          | 1855/50          | 1855/50                   | 1855/50     |   |   |   |
|                            | Push button modules                      | Repertory module | -                         | -           | - | - | - |
| FLUSH MOUNTED (#)          | Module frames with embedding box         | 2 x 825/24       | 3 x 825/23                | 3 x 825/23  |   |   |   |
| FLUSH-MOUNTING ACCESSORIES | Wall cover frame (°)                     | 825/408          | 825/39                    | 825/39      |   |   |   |
|                            | Rain hood with wall cover frame (°)      | 825/442          | 825/49                    | 825/49      |   |   |   |
| WALL MOUNTED (#)           | Case with hood, frame and module holders | 825/542          | 825/59                    | 825/59      |   |   |   |

(°) alternatives  
(#) alternatives

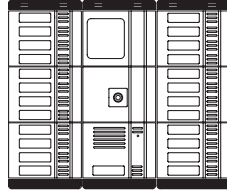

**25**

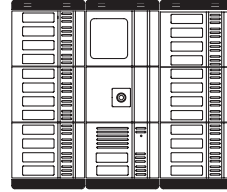

**26**

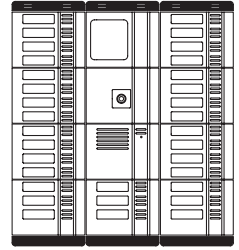

**33**

|                            |  |                  |             |                           |
|----------------------------|--|------------------|-------------|---------------------------|
|                            | Camera unit module                       | 1855/70          | 1855/70     | 1855/70                   |
|                            | Loudspeaking units                       | 824/500          | 824/500     | 824/500                   |
|                            | Modules arranged for loudspeaking unit   | 825/211          | 825/212     | 825/210                   |
|                            | Button module                            | 6 x 825/204      | 6 x 825/204 | 3 x 825/203 - 6 x 825/204 |
|                            | Lighting module                          | 1855/50          | 1855/50     | 1855/50                   |
|                            | Push button modules                      | Repertory module | -           | -                         |
| FLUSH MOUNTED (#)          | Module frames with embedding box         | 3 x 825/23       | 3 x 825/23  | 3 x 825/24                |
| FLUSH-MOUNTING ACCESSORIES | Wall cover frame (°)                     | 825/39           | 825/39      | 825/412                   |
|                            | Rain hood with wall cover frame (°)      | 825/49           | 825/49      | 825/443                   |
| WALL MOUNTED (#)           | Case with hood, frame and module holders | 825/59           | 825/59      | 825/543                   |

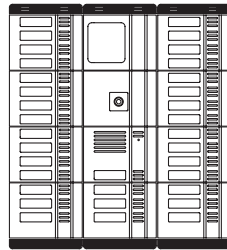

**34**

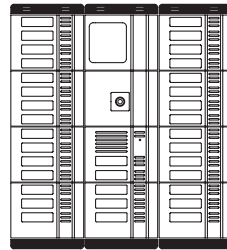

**35**

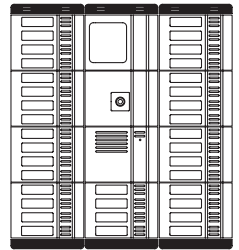

**36**

|                            |  |                           |                           |             |
|----------------------------|--|---------------------------|---------------------------|-------------|
|                            | Camera unit module                       | 1855/70                   | 1855/70                   | 1855/70     |
|                            | Loudspeaking units                       | 824/500                   | 824/500                   | 824/500     |
|                            | Modules arranged for loudspeaking unit   | 825/211                   | 825/212                   | 825/210     |
|                            | Button module                            | 3 x 825/203 - 6 x 825/204 | 3 x 825/203 - 6 x 825/204 | 9 x 825/204 |
|                            | Lighting module                          | 1855/50                   | 1855/50                   | 1855/50     |
|                            | Push button modules                      | Repertory module          | -                         | -           |
| FLUSH MOUNTED (#)          | Module frames with embedding box         | 3 x 825/24                | 3 x 825/24                | 3 x 825/24  |
| FLUSH-MOUNTING ACCESSORIES | Wall cover frame (°)                     | 825/412                   | 825/412                   | 825/412     |
|                            | Rain hood with wall cover frame (°)      | 825/443                   | 825/443                   | 825/443     |
| WALL MOUNTED (#)           | Case with hood, frame and module holders | 825/543                   | 825/543                   | 825/543     |

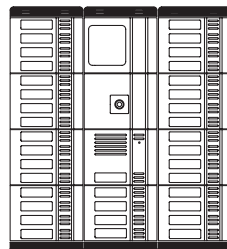

**37**

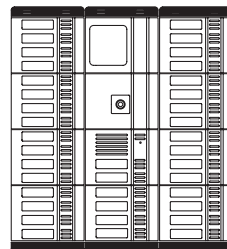

**38**

|                            |  |                  |             |
|----------------------------|--|------------------|-------------|
|                            | Camera unit module                       | 1855/70          | 1855/70     |
|                            | Loudspeaking units                       | 824/500          | 824/500     |
|                            | Modules arranged for loudspeaking unit   | 825/211          | 825/212     |
|                            | Button module                            | 9 x 825/204      | 9 x 825/204 |
|                            | Lighting module                          | 1855/50          | 1855/50     |
|                            | Push button modules                      | Repertory module | -           |
| FLUSH MOUNTED (#)          | Module frames with embedding box         | 3 x 825/24       | 3 x 825/24  |
| FLUSH-MOUNTING ACCESSORIES | Wall cover frame (°)                     | 825/412          | 825/412     |
|                            | Rain hood with wall cover frame (°)      | 825/443          | 825/443     |
| WALL MOUNTED (#)           | Case with hood, frame and module holders | 825/543          | 825/543     |

### EXAMPLES OF MODULAR CONSTRUCTIONS WITH VARIOUS CAPACITIES

(°) alternatives  
(#) alternatives

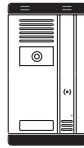

1

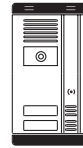

2

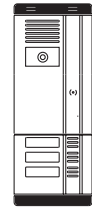

3

|                                   |  |                  |        |   |        |   |         |   |
|-----------------------------------|--|------------------|--------|---|--------|---|---------|---|
| Camera unit module with door unit |  |                  | 955/21 |   | 955/22 |   | 955/20  |   |
|                                   | Button modules                           | Repertory module | -      | - | -      | - | 825/203 | - |
|                                   | Conversation privacy device              |                  | -      |   | -      |   | 1035/74 |   |
| FLUSH MOUNTED (#)                 | Module frames with embedding box         |                  | 825/22 |   | 825/22 |   | 825/23  |   |
| FLUSH-MOUNTING ACCESSORIES        | Wall cover frame (°)                     |                  | 825/32 |   | 825/32 |   | 825/33  |   |
|                                   | Rain hood with wall cover frame (°)      |                  | 825/42 |   | 825/42 |   | 825/43  |   |
| WALL MOUNTED (#)                  | Case with hood, frame and module holders |                  | 825/52 |   | 825/52 |   | 825/53  |   |

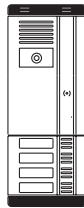

4



5

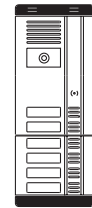

6

|                                   |  |                  |         |   |         |   |         |   |
|-----------------------------------|--|------------------|---------|---|---------|---|---------|---|
| Camera unit module with door unit |  |                  | 955/20  |   | 955/21  |   | 955/22  |   |
|                                   | Button modules                           | Repertory module | 825/204 | - | 825/204 | - | 825/204 | - |
|                                   | Conversation privacy device              |                  | 1035/74 |   | 1035/74 |   | 1035/74 |   |
| FLUSH MOUNTED (#)                 | Module frames with embedding box         |                  | 825/23  |   | 825/23  |   | 825/23  |   |
| FLUSH-MOUNTING ACCESSORIES        | Wall cover frame (°)                     |                  | 825/33  |   | 825/33  |   | 825/33  |   |
|                                   | Rain hood with wall cover frame (°)      |                  | 825/43  |   | 825/43  |   | 825/43  |   |
| WALL MOUNTED (#)                  | Case with hood, frame and module holders |                  | 825/53  |   | 825/53  |   | 825/53  |   |

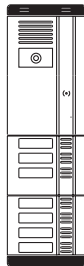

7



8



9

|                                   |  |                  |                           |   |             |   |             |   |
|-----------------------------------|--|------------------|---------------------------|---|-------------|---|-------------|---|
| Camera unit module with door unit |  |                  | 955/20                    |   | 955/20      |   | 955/21      |   |
|                                   | Button modules                           | Repertory module | 1 x 825/203 - 1 x 825/204 | - | 2 x 825/204 | - | 2 x 825/204 | - |
|                                   | Conversation privacy device              |                  | 2 x 1035/74               |   | 2 x 1035/74 |   | 2 x 1035/74 |   |
| FLUSH MOUNTED (#)                 | Module frames with embedding box         |                  | 825/23                    |   | 825/23      |   | 825/23      |   |
| FLUSH-MOUNTING ACCESSORIES        | Wall cover frame (°)                     |                  | 825/33                    |   | 825/33      |   | 825/33      |   |
|                                   | Rain hood with wall cover frame (°)      |                  | 825/43                    |   | 825/43      |   | 825/43      |   |
| WALL MOUNTED (#)                  | Case with hood, frame and module holders |                  | 825/53                    |   | 825/53      |   | 825/53      |   |

(°) alternatives  
(#) alternatives



10



7

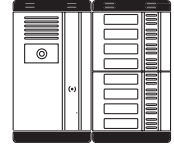

8

|                            |  |             |   |                           |   |             |   |
|----------------------------|--|-------------|---|---------------------------|---|-------------|---|
|                            | Camera unit module with door unit        | 955/22      |   | 955/20                    |   | 955/20      |   |
|                            | Button modules                           | 2 x 825/204 | - | 1 x 825/203 - 1 x 825/204 | - | 2 x 825/204 | - |
|                            | Conversation privacy device              | 2 x 1035/74 |   | 2 x 1035/74               |   | 2 x 1035/74 |   |
| FLUSH MOUNTED (#)          | Module frames with embedding box         | 825/24      |   | 2 x 825/22                |   | 2 x 825/22  |   |
| FLUSH-MOUNTING ACCESSORIES | Wall cover frame (°)                     | 825/404     |   | 825/34                    |   | 825/34      |   |
|                            | Rain hood with wall cover frame (°)      | 825/441     |   | 825/44                    |   | 825/44      |   |
| WALL MOUNTED (#)           | Case with hood, frame and module holders | 825/541     |   | 825/54                    |   | 825/54      |   |

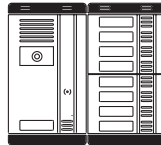

9



10

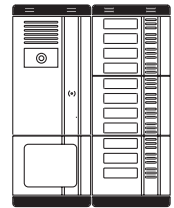

11

|                            |  |             |   |             |   |                           |       |
|----------------------------|--|-------------|---|-------------|---|---------------------------|-------|
|                            | Camera unit module with door unit        | 955/21      |   | 955/22      |   | 955/20                    |       |
|                            | Button modules                           | 2 x 825/204 | - | 2 x 825/204 | - | 1 x 825/203 - 2 x 825/204 | 825/5 |
|                            | Conversation privacy device              | 2 x 1035/74 |   | 2 x 1035/74 |   | 3 x 1035/74               |       |
| FLUSH MOUNTED (#)          | Module frames with embedding box         | 2 x 825/22  |   | 2 x 825/22  |   | 2 x 825/23                |       |
| FLUSH-MOUNTING ACCESSORIES | Wall cover frame (°)                     | 825/34      |   | 825/34      |   | 825/36                    |       |
|                            | Rain hood with wall cover frame (°)      | 825/44      |   | 825/44      |   | 825/46                    |       |
| WALL MOUNTED (#)           | Case with hood, frame and module holders | 825/54      |   | 825/54      |   | 825/56                    |       |

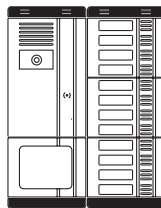

12

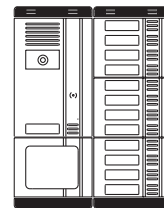

13

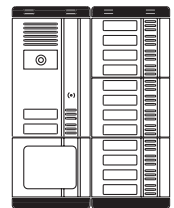

14

|                            |  |             |       |             |       |             |       |
|----------------------------|--|-------------|-------|-------------|-------|-------------|-------|
|                            | Camera unit module with door unit        | 955/20      |       | 955/21      |       | 955/22      |       |
|                            | Button modules                           | 3 x 825/204 | 825/5 | 3 x 825/204 | 825/5 | 3 x 825/204 | 825/5 |
|                            | Conversation privacy device              | 3 x 1035/74 |       | 3 x 1035/74 |       | 3 x 1035/74 |       |
| FLUSH MOUNTED (#)          | Module frames with embedding box         | 2 x 825/23  |       | 2 x 825/23  |       | 2 x 825/23  |       |
| FLUSH-MOUNTING ACCESSORIES | Wall cover frame (°)                     | 825/36      |       | 825/36      |       | 825/36      |       |
|                            | Rain hood with wall cover frame (°)      | 825/46      |       | 825/46      |       | 825/46      |       |
| WALL MOUNTED (#)           | Case with hood, frame and module holders | 825/56      |       | 825/56      |       | 825/56      |       |

### EXAMPLES OF MODULAR CONSTRUCTIONS WITH VARIOUS CAPACITIES

(°) alternatives  
(#) alternatives

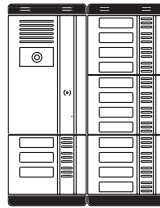

**15**

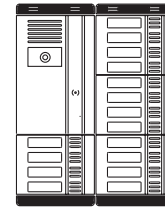

**16**

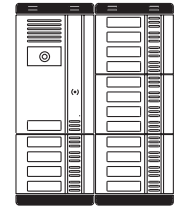

**17**

|                            |  |                  |                           |        |             |        |             |  |
|----------------------------|--|------------------|---------------------------|--------|-------------|--------|-------------|--|
|                            | Camera unit module with door unit        | 955/20           |                           | 955/20 |             | 955/21 |             |  |
|                            | Button modules                           | Repertory module | 1 x 825/203 - 3 x 825/204 | -      | 4 x 825/204 | -      | 4 x 825/204 |  |
|                            | Conversation privacy device              |                  | 4 x 1035/74               |        | 4 x 1035/74 |        | 4 x 1035/74 |  |
| FLUSH MOUNTED (#)          | Module frames with embedding box         |                  | 2 x 825/23                |        | 2 x 825/23  |        | 2 x 825/23  |  |
| FLUSH-MOUNTING ACCESSORIES | Wall cover frame (°)                     |                  | 825/36                    |        | 825/36      |        | 825/36      |  |
|                            | Rain hood with wall cover frame (°)      |                  | 825/46                    |        | 825/46      |        | 825/46      |  |
| WALL MOUNTED (#)           | Case with hood, frame and module holders |                  | 825/56                    |        | 825/56      |        | 825/56      |  |

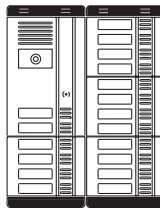

**18**

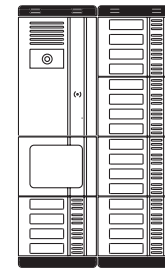

**20**

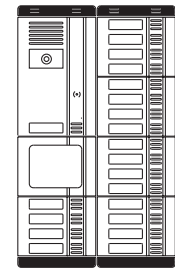

**21**

|                            |  |                  |             |        |             |        |             |  |
|----------------------------|--|------------------|-------------|--------|-------------|--------|-------------|--|
|                            | Camera unit module with door unit        | 955/22           |             | 955/20 |             | 955/21 |             |  |
|                            | Button modules                           | Repertory module | 4 x 825/204 | -      | 5 x 825/204 | 825/5  | 5 x 825/204 |  |
|                            | Conversation privacy device              |                  | 4 x 1035/74 |        | 5 x 1035/74 |        | 5 x 1035/74 |  |
| FLUSH MOUNTED (#)          | Module frames with embedding box         |                  | 2 x 825/23  |        | 2 x 825/24  |        | 2 x 825/24  |  |
| FLUSH-MOUNTING ACCESSORIES | Wall cover frame (°)                     |                  | 825/36      |        | 825/408     |        | 825/408     |  |
|                            | Rain hood with wall cover frame (°)      |                  | 825/46      |        | 825/442     |        | 825/442     |  |
| WALL MOUNTED (#)           | Case with hood, frame and module holders |                  | 825/56      |        | 825/542     |        | 825/542     |  |

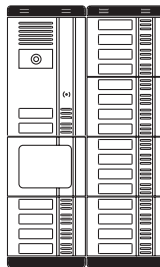

**22**

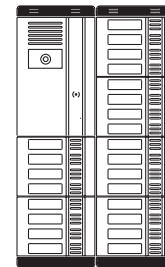

**24**

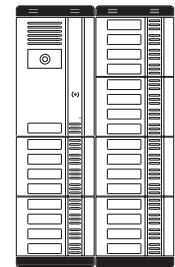

**25**

|                            |  |                  |             |        |             |        |             |  |
|----------------------------|--|------------------|-------------|--------|-------------|--------|-------------|--|
|                            | Camera unit module with door unit        | 955/22           |             | 955/20 |             | 955/21 |             |  |
|                            | Button modules                           | Repertory module | 5 x 825/204 | 825/5  | 6 x 825/204 | -      | 6 x 825/204 |  |
|                            | Conversation privacy device              |                  | 5 x 1035/74 |        | 6 x 1035/74 |        | 6 x 1035/74 |  |
| FLUSH MOUNTED (#)          | Module frames with embedding box         |                  | 2 x 825/24  |        | 2 x 825/24  |        | 2 x 825/24  |  |
| FLUSH-MOUNTING ACCESSORIES | Wall cover frame (°)                     |                  | 825/408     |        | 825/408     |        | 825/408     |  |
|                            | Rain hood with wall cover frame (°)      |                  | 825/442     |        | 825/442     |        | 825/442     |  |
| WALL MOUNTED (#)           | Case with hood, frame and module holders |                  | 825/542     |        | 825/542     |        | 825/542     |  |



(°) alternatives  
(#) alternatives

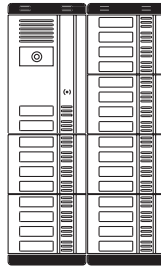

**26**

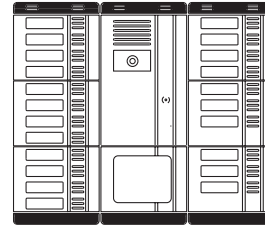

**22**

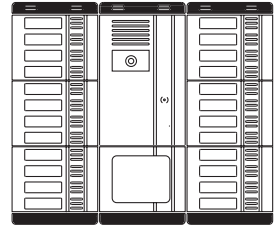

**24**

|                            |  |                  |             |        |                           |        |             |
|----------------------------|--|------------------|-------------|--------|---------------------------|--------|-------------|
|                            | Camera unit module with door unit        | 955/22           |             | 955/20 |                           | 955/20 |             |
|                            | Button modules                           | Repertory module | 6 x 825/204 | -      | 2 x 825/203 - 4 x 825/204 | 825/5  | 6 x 825/204 |
|                            | Conversation privacy device              |                  | 6 x 1035/74 |        | 6 x 1035/74               |        | 825/5       |
| FLUSH MOUNTED (#)          | Module frames with embedding box         |                  | 2 x 825/24  |        | 3 x 825/23                |        | 3 x 825/23  |
| FLUSH-MOUNTING ACCESSORIES | Wall cover frame (°)                     |                  | 825/408     |        | 825/39                    |        | 825/39      |
|                            | Rain hood with wall cover frame (°)      |                  | 825/442     |        | 825/49                    |        | 825/49      |
| WALL MOUNTED (#)           | Case with hood, frame and module holders |                  | 825/542     |        | 825/59                    |        | 825/59      |

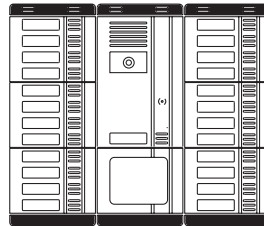

**25**

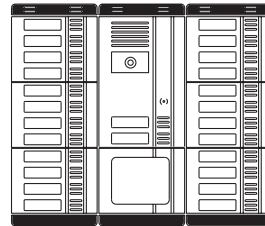

**26**

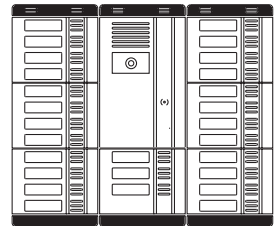

**27**

|                            |  |                  |             |        |             |        |                           |
|----------------------------|--|------------------|-------------|--------|-------------|--------|---------------------------|
|                            | Camera unit module with door unit        | 955/21           |             | 955/22 |             | 955/20 |                           |
|                            | Button modules                           | Repertory module | 6 x 825/204 | 825/5  | 6 x 825/204 | 825/5  | 1 x 825/203 - 6 x 825/204 |
|                            | Conversation privacy device              |                  | 6 x 1035/74 |        | 6 x 1035/74 |        | 7 x 1035/74               |
| FLUSH MOUNTED (#)          | Module frames with embedding box         |                  | 3 x 825/23  |        | 3 x 825/23  |        | 3 x 825/23                |
| FLUSH-MOUNTING ACCESSORIES | Wall cover frame (°)                     |                  | 825/39      |        | 825/39      |        | 825/39                    |
|                            | Rain hood with wall cover frame (°)      |                  | 825/49      |        | 825/49      |        | 825/49                    |
| WALL MOUNTED (#)           | Case with hood, frame and module holders |                  | 825/59      |        | 825/59      |        | 825/59                    |

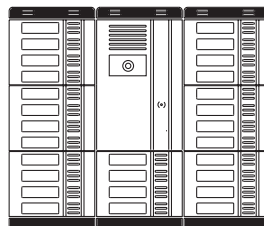

**28**

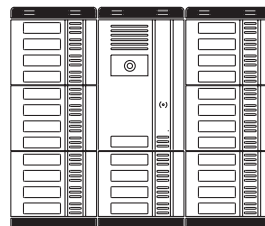

**29**

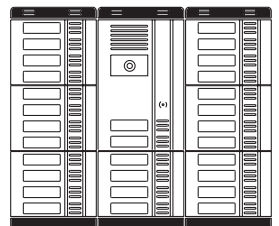

**30**

|                            |  |                  |             |        |             |        |             |
|----------------------------|--|------------------|-------------|--------|-------------|--------|-------------|
|                            | Camera unit module with door unit        | 955/20           |             | 955/21 |             | 955/22 |             |
|                            | Button modules                           | Repertory module | 7 x 825/204 | -      | 7 x 825/204 | -      | 7 x 825/204 |
|                            | Conversation privacy device              |                  | 7 x 1035/74 |        | 7 x 1035/74 |        | 7 x 1035/74 |
| FLUSH MOUNTED (#)          | Module frames with embedding box         |                  | 3 x 825/23  |        | 3 x 825/23  |        | 3 x 825/23  |
| FLUSH-MOUNTING ACCESSORIES | Wall cover frame (°)                     |                  | 825/39      |        | 825/39      |        | 825/39      |
|                            | Rain hood with wall cover frame (°)      |                  | 825/49      |        | 825/49      |        | 825/49      |
| WALL MOUNTED (#)           | Case with hood, frame and module holders |                  | 825/59      |        | 825/59      |        | 825/59      |

### EXAMPLES OF MODULAR CONSTRUCTIONS WITH VARIOUS CAPACITIES

(°) alternatives  
(#) alternatives

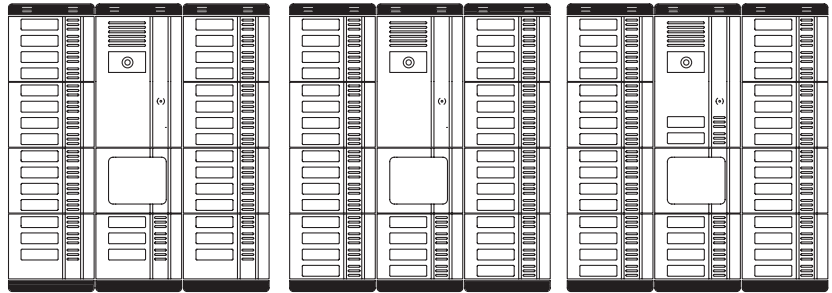

**33**

**36**

**38**

|                            |  |                  |                           |        |             |        |             |
|----------------------------|--|------------------|---------------------------|--------|-------------|--------|-------------|
|                            | Camera unit module with door unit        | 955/20           |                           | 955/20 |             | 955/22 |             |
|                            | Button modules                           | Repertory module | 3 x 825/203 - 6 x 825/204 | 825/5  | 9 x 825/204 | 825/5  | 9 x 825/204 |
|                            | Conversation privacy device              |                  | 9 x 1035/74               |        | 9 x 1035/74 |        | 9 x 1035/74 |
| FLUSH MOUNTED (#)          | Module frames with embedding box         |                  | 3 x 825/24                |        | 3 x 825/24  |        | 3 x 825/24  |
| FLUSH-MOUNTING ACCESSORIES | Wall cover frame (°)                     |                  | 825/412                   |        | 825/412     |        | 825/412     |
|                            | Rain hood with wall cover frame (°)      |                  | 825/443                   |        | 825/443     |        | 825/443     |
| WALL MOUNTED (#)           | Case with hood, frame and module holders |                  | 825/543                   |        | 825/543     |        | 825/543     |

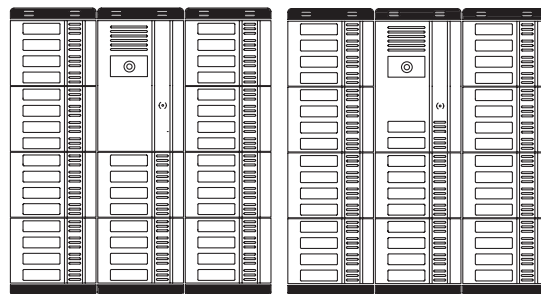

**40**

**42**

|                            |  |                  |              |        |              |
|----------------------------|--|------------------|--------------|--------|--------------|
|                            | Camera unit module with door unit                            | 955/20           |              | 955/22 |              |
|                            | Button modules   | Repertory module | 10 x 825/204 | -      | 10 x 825/204 |
|                            | Conversation privacy device                                  |                  | 10 x 1035/74 |        | 10 x 1035/74 |
| FLUSH MOUNTED (#)          | Module frames with embedding box                             |                  | 3 x 825/24   |        | 3 x 825/24   |
| FLUSH-MOUNTING ACCESSORIES | Wall cover frame (°)   |                  | 825/412      |        | 825/412      |
|                            | Rain hood with wall cover frame (°)                          |                  | 825/443      |        | 825/443      |
| WALL MOUNTED (#)           | Custodia con visiera completa di cornice e telai portamoduli |                  | 825/543      |        | 825/543      |

(°) alternatives  
(#) alternatives

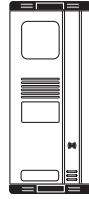

1

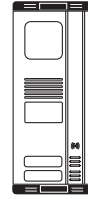

2

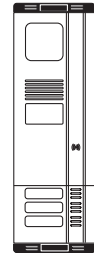

3

|                            |   |                  |         |         |   |
|----------------------------|---|------------------|---------|---------|---|
|                            | Camera unit module with door unit and illuminator | 1855/21          | 1855/22 | 1855/20 |   |
|                            | Button modules                                    | -                | -       | 825/203 |   |
|                            | Push button modules                               | Repertory module | -       | -       | - |
|                            | Conversation privacy device                       | -                | -       | 1035/74 |   |
| FLUSH MOUNTED (#)          | Module frames with embedding box                  | 825/23           | 825/23  | 825/24  |   |
| FLUSH-MOUNTING ACCESSORIES | Wall cover frame (°)                              | 825/33           | 825/33  | 825/404 |   |
|                            | Rain hood with wall cover frame (°)               | 825/43           | 825/43  | 825/441 |   |
| WALL MOUNTED (#)           | Case with hood, frame and module holders          | 825/53           | 825/53  | 825/541 |   |

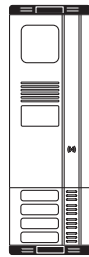

4



5

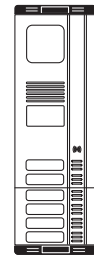

6

|                            |   |                  |         |         |   |
|----------------------------|---|------------------|---------|---------|---|
|                            | Camera unit module with door unit and illuminator | 1855/20          | 1855/21 | 1855/22 |   |
|                            | Button modules                                    | 825/204          | 825/204 | 825/204 |   |
|                            | Push button modules                               | Repertory module | -       | -       | - |
|                            | Conversation privacy device                       | 1035/74          | 1035/74 | 1035/74 |   |
| FLUSH MOUNTED (#)          | Module frames with embedding box                  | 825/24           | 825/24  | 825/24  |   |
| FLUSH-MOUNTING ACCESSORIES | Wall cover frame (°)                              | 825/404          | 825/404 | 825/404 |   |
|                            | Rain hood with wall cover frame (°)               | 825/441          | 825/441 | 825/441 |   |
| WALL MOUNTED (#)           | Case with hood, frame and module holders          | 825/541          | 825/541 | 825/541 |   |

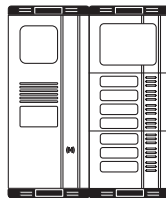

7

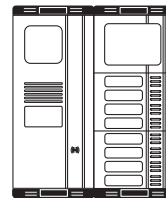

8

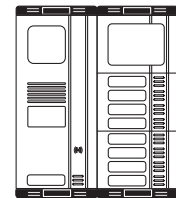

9

|                            |   |                           |             |             |   |
|----------------------------|---|---------------------------|-------------|-------------|---|
|                            | Camera unit module with door unit and illuminator | 1855/20                   | 1855/20     | 1855/21     |   |
|                            | Button modules                                    | 1 x 825/203 - 1 x 825/204 | 2 x 825/204 | 2 x 825/204 |   |
|                            | Push button modules                               | Repertory module          | -           | 825/5       | - |
|                            | Conversation privacy device                       | 2 x 1035/74               | 2 x 1035/74 | 2 x 1035/74 |   |
| FLUSH MOUNTED (#)          | Module frames with embedding box                  | 2 x 825/23                | 2 x 825/23  | 2 x 825/23  |   |
| FLUSH-MOUNTING ACCESSORIES | Wall cover frame (°)                              | 825/36                    | 825/36      | 825/36      |   |
|                            | Rain hood with wall cover frame (°)               | 825/46                    | 825/46      | 825/46      |   |
| WALL MOUNTED (#)           | Case with hood, frame and module holders          | 825/56                    | 825/56      | 825/56      |   |

(°) alternatives  
(#) alternatives

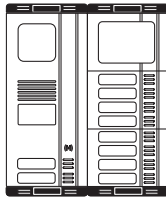

**10**

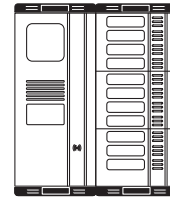

**11**

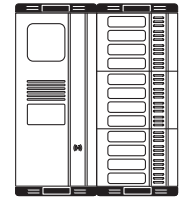

**12**

|                            |   |                  |                           |             |   |   |
|----------------------------|---|------------------|---------------------------|-------------|---|---|
|                            | Camera unit module with door unit and illuminator | 1855/22          | 1855/20                   | 1855/20     |   |   |
|                            | Button modules                                    | 2 x 825/204      | 1 x 825/203 - 2 x 825/204 | 3 x 825/204 |   |   |
|                            | Push button modules                               | Repertory module | -                         | 825/5       | - | - |
|                            | Conversation privacy device                       | 2 x 1035/74      | 3 x 1035/74               | 3 x 1035/74 |   |   |
| FLUSH MOUNTED (#)          | Module frames with embedding box                  | 2 x 825/23       | 2 x 825/23                | 2 x 825/23  |   |   |
| FLUSH-MOUNTING ACCESSORIES | Wall cover frame (°)                              | 825/36           | 825/36                    | 825/36      |   |   |
|                            | Rain hood with wall cover frame (°)               | 825/46           | 825/46                    | 825/46      |   |   |
| WALL MOUNTED (#)           | Case with hood, frame and module holders          | 825/56           | 825/56                    | 825/56      |   |   |

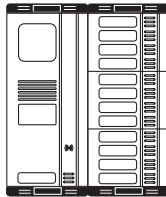

**13**

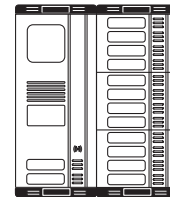

**14**

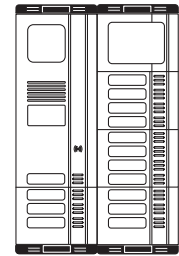

**15**

|                            |   |                  |             |                           |       |
|----------------------------|---|------------------|-------------|---------------------------|-------|
|                            | Camera unit module with door unit and illuminator | 1855/21          | 1855/22     | 1855/21                   |       |
|                            | Button modules                                    | 3 x 825/204      | 3 x 825/204 | 2 x 825/203 - 2 x 825/204 |       |
|                            | Push button modules                               | Repertory module | -           | -                         | 825/5 |
|                            | Conversation privacy device                       | 3 x 1035/74      | 3 x 1035/74 | 4 x 1035/74               |       |
| FLUSH MOUNTED (#)          | Module frames with embedding box                  | 2 x 825/23       | 2 x 825/23  | 2 x 825/24                |       |
| FLUSH-MOUNTING ACCESSORIES | Wall cover frame (°)                              | 825/36           | 825/36      | 825/408                   |       |
|                            | Rain hood with wall cover frame (°)               | 825/46           | 825/46      | 825/442                   |       |
| WALL MOUNTED (#)           | Case with hood, frame and module holders          | 825/56           | 825/56      | 825/542                   |       |

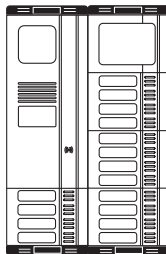

**16**

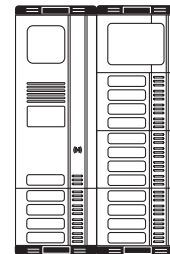

**17**

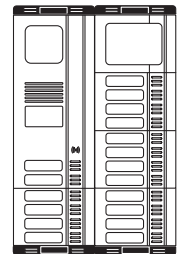

**18**

|                            |   |                  |             |             |   |       |
|----------------------------|---|------------------|-------------|-------------|---|-------|
|                            | Camera unit module with door unit and illuminator | 1855/20          | 1855/21     | 1855/22     |   |       |
|                            | Button modules                                    | 4 x 825/204      | 4 x 825/204 | 4 x 825/204 |   |       |
|                            | Push button modules                               | Repertory module | -           | 825/5       | - | 825/5 |
|                            | Conversation privacy device                       | 4 x 1035/74      | 4 x 1035/74 | 4 x 1035/74 |   |       |
| FLUSH MOUNTED (#)          | Module frames with embedding box                  | 2 x 825/24       | 2 x 825/24  | 2 x 825/24  |   |       |
| FLUSH-MOUNTING ACCESSORIES | Wall cover frame (°)                              | 825/408          | 825/408     | 825/408     |   |       |
|                            | Rain hood with wall cover frame (°)               | 825/442          | 825/442     | 825/442     |   |       |
| WALL MOUNTED (#)           | Case with hood, frame and module holders          | 825/542          | 825/542     | 825/542     |   |       |

(°) alternatives  
(#) alternatives

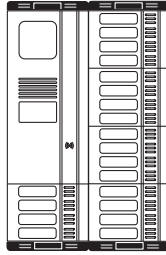

20

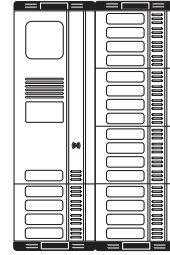

21

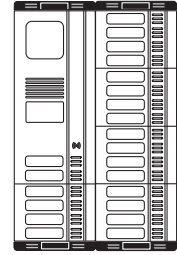

22

|                            |   |                  |             |             |
|----------------------------|---|------------------|-------------|-------------|
|                            | Camera unit module with door unit and illuminator | 1855/20          | 1855/21     | 1855/22     |
|                            | Button modules                                    | 5 x 825/204      | 5 x 825/204 | 5 x 825/204 |
|                            | Push button modules                               | Repertory module | -           | -           |
|                            | Conversation privacy device                       | 5 x 1035/74      | 5 x 1035/74 | 5 x 1035/74 |
| FLUSH MOUNTED (#)          | Module frames with embedding box                  | 2 x 825/24       | 2 x 825/24  | 2 x 825/24  |
| FLUSH-MOUNTING ACCESSORIES | Wall cover frame (°)                              | 825/408          | 825/408     | 825/408     |
|                            | Rain hood with wall cover frame (°)               | 825/442          | 825/442     | 825/442     |
| WALL MOUNTED (#)           | Case with hood, frame and module holders          | 825/542          | 825/542     | 825/542     |

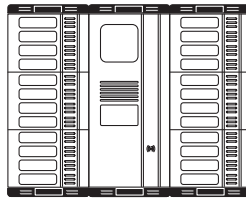

24

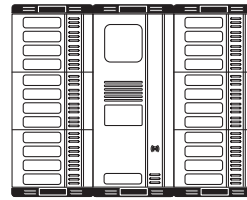

25

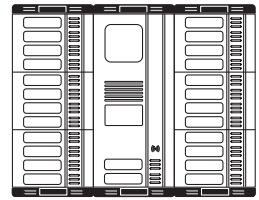

26

|                            |   |                  |             |             |
|----------------------------|---|------------------|-------------|-------------|
|                            | Camera unit module with door unit and illuminator | 1855/20          | 1855/21     | 1855/22     |
|                            | Button modules                                    | 6 x 825/204      | 6 x 825/204 | 6 x 825/204 |
|                            | Push button modules                               | Repertory module | -           | -           |
|                            | Conversation privacy device                       | 6 x 1035/74      | 6 x 1035/74 | 6 x 1035/74 |
| FLUSH MOUNTED (#)          | Module frames with embedding box                  | 3 x 825/23       | 3 x 825/23  | 3 x 825/23  |
| FLUSH-MOUNTING ACCESSORIES | Wall cover frame (°)                              | 825/39           | 825/39      | 825/39      |
|                            | Rain hood with wall cover frame (°)               | 825/49           | 825/49      | 825/49      |
| WALL MOUNTED (#)           | Case with hood, frame and module holders          | 825/59           | 825/59      | 825/59      |

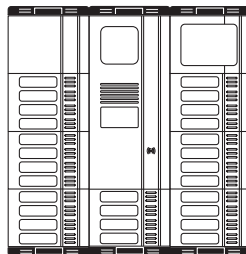

28

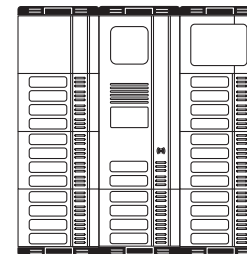

30

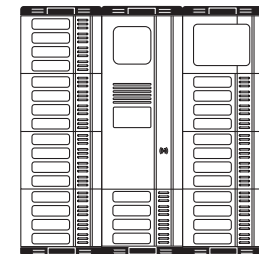

32

|                            |   |                  |             |             |   |       |
|----------------------------|---|------------------|-------------|-------------|---|-------|
|                            | Camera unit module with door unit and illuminator | 1855/20          | 1855/22     | 1855/20     |   |       |
|                            | Button modules                                    | 7 x 825/204      | 7 x 825/204 | 8 x 825/204 |   |       |
|                            | Push button modules                               | Repertory module | 825/9       | 825/5       | - | 825/5 |
|                            | Conversation privacy device                       | 7 x 1035/74      | 7 x 1035/74 | 8 x 1035/74 |   |       |
| FLUSH MOUNTED (#)          | Module frames with embedding box                  | 3 x 825/24       | 3 x 825/24  | 3 x 825/24  |   |       |
| FLUSH-MOUNTING ACCESSORIES | Wall cover frame (°)                              | 825/412          | 825/412     | 825/412     |   |       |
|                            | Rain hood with wall cover frame (°)               | 825/443          | 825/443     | 825/443     |   |       |
| WALL MOUNTED (#)           | Case with hood, frame and module holders          | 825/543          | 825/543     | 825/543     |   |       |



## KOMBI PUSH BUTTON PANEL COLOUR COAX VIDEO DOOR PHONE SYSTEMS



### EXAMPLES OF MODULAR CONSTRUCTIONS WITH VARIOUS CAPACITIES

(°) alternatives  
(#) alternatives

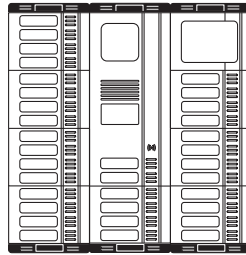

**34**

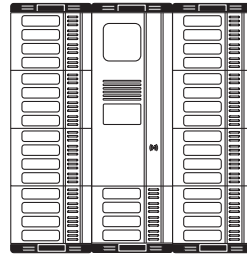

**36**

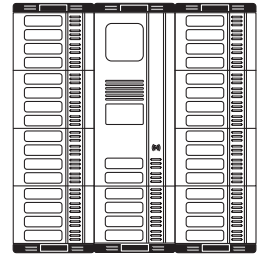

**38**

|                            |   |             |                  |             |
|----------------------------|---|-------------|------------------|-------------|
|                            | Camera unit module with door unit and illuminator | 1855/22     | 1855/20          | 1855/22     |
|                            | Button modules                                    | 8 x 825/204 | 9 x 825/204      | 9 x 825/204 |
|                            | Push button modules                               |             | Repertory module |             |
|                            |   | -           | 825/5            | -           |
|                            | Conversation privacy device                       | 8 x 1035/74 | 9 x 1035/74      | 9 x 1035/74 |
| FLUSH MOUNTED (#)          | Module frames with embedding box                  | 3 x 825/24  | 3 x 825/24       | 3 x 825/24  |
| FLUSH-MOUNTING ACCESSORIES | Wall cover frame (°)                              | 825/412     | 825/412          | 825/412     |
|                            | Rain hood with wall cover frame (°)               | 825/443     | 825/443          | 825/443     |
| WALL MOUNTED (#)           | Case with hood, frame and module holders          | 825/543     | 825/543          | 825/543     |